



中华人民共和国国家标准

GB/T 786.1—2009/ISO 1219-1:2006
代替 GB/T 786.1—1993

流体传动系统及元件图形符号和回路图 第 1 部分：用于常规用途和数据处理的 图形符号

Fluid power systems and components—Graphic symbols and circuit diagrams—
Part 1; Graphic symbols for conventional use and data-processing applications

(ISO 1219-1:2006, IDT)

2009-03-16 发布

2009-11-01 实施

中华人民共和国国家质量监督检验检疫总局 发布
中国国家标准化管理委员会



目 次

前言	I
1 范围	1
2 规范性引用文件	1
3 术语和定义	1
4 标注说明(引用 GB/T 786 的本部分)	1
5 总则	1
6 液压应用实例	2
6.1 阀	2
6.2 泵和马达	31
6.3 缸	36
6.4 附件	39
7 气动应用实例	49
7.1 阀	49
7.2 空气压缩机和马达	64
7.3 缸	66
7.4 附件	70
8 图形符号的基本要素	80
8.1 线	80
8.2 连接和管接头	80
8.3 流路和方向指示	82
8.4 机械基本要素	85
8.5 控制机构要素	95
8.6 调节要素	101
8.7 附件	102
9 应用规则	109
9.1 常规符号	109
9.2 阀	109
9.3 二通盖板式插装阀	114
9.4 泵和马达	115
9.5 缸	116
9.6 附件	117
附录 A (资料性附录) CAD 符号介绍	120
参考文献	126

前 言

GB/T 786《流体传动系统及元件图形符号和回路图》分为两部分：

- 第1部分：用于常规用途和数据处理的图形符号；
- 第2部分：回路图。

本部分为 GB/T 786 的第1部分，等同采用 ISO 1219-1:2006《流体传动系统和元件 图形符号和回路图 第1部分：用于常规用途和数据处理的图形符号》(英文版)。

本部分等同翻译 ISO 1219-1:2006。

为便于使用，本部分做了下列编辑性修改：

- 在“2 规范性引用文件”中，以相应的国家标准代替国际标准。
- ISO 1219-1:2006 的 8.5.26 条款号重复，在 GB/T 786.1 中进行调整，顺延 8.5.26~8.5.31 为 8.5.26~8.5.32。
- 对 ISO 1219-1:2006 的 6.1.6.4 和 6.1.8.1 的图进行了修正。
- 对 ISO 1219-1:2006 的 6.1.9.6 的“ ≥ 0.7 ”，修正为“ > 0.7 ”。

本部分代替 GB/T 786.1—1993《液压气动图形符号》，与前版相比主要变化如下：

- 标准名称更改为《流体传动系统及元件图形符号和回路图 第1部分：用于常规用途和数据处理的图形符号》；
- 在“1 范围”中，增加与 GB/T 20063《简图用图形符号》系列标准关系的说明；
- 在“3 术语和定义”中，删除单独规定的“术语”，直接引用“GB/T 17446 确立的术语和定义”；
- 增加第4章“标注说明”；
- 第5章“总则”对本标准中所增加“注册号”给出应用说明；
- 所给出的图形符号的表格结构更简洁，序列划分更便于应用，并增加“注册号”列。

本部分的附录 A 为资料性附录。

本部分由中国机械工业联合会提出。

本部分由全国液压气动标准化技术委员会(SAC/TC 3)归口。

本部分起草单位：北京机械工业自动化研究所、北京航空航天大学、无锡气动技术研究有限公司。

本部分主要起草人：赵曼琳、李运华、蔡茂林、刘新德、杨燧然、李企芳。

本部分所替代标准的历次版本发布情况为：

- GB 786—1965、GB 786—1976、GB/T 786.1—1993。

流体传动系统及元件图形符号和回路图

第1部分:用于常规用途和数据处理的图形符号

1 范围

GB/T 786 的本部分建立了各种符号的基本要素,并制定了液压气动元件和回路图表中符号的设计规则。

本部分内容是 GB/T 20063 系列标准的综合应用。本部分中各类符号按照固定尺寸设计,以便于直接应用在数据处理系统中,并生成各种变量。

2 规范性引用文件

下列文件中的条款通过 GB/T 786 的本部分的引用而成为本部分的条款。凡是注日期的引用文件,其随后所有的修改单(不包括勘误的内容)或修订版均不适用于本部分,然而,鼓励根据本部分达成协议的各方研究是否可使用这些文件的最新版本。凡是不注日期的引用文件,其最新版本适用于本部分。

GB/T 4457.4 机械制图 图样画法 图线(GB/T 4457.4—2002,ISO 128-24:1999,MOD)

GB/T 16901.2 图形符号表示规则 产品技术文件用图形符号 第2部分:图形符号(包括基准符号库中的图形符号)的计算机电子文件格式规范及其交换要求(GB/T 16901.2—2000,eqv IEC 81714-2:1998)

GB/T 17446 流体传动系统及元件 术语(GB/T 17446—1998,idt ISO 5598:1985)

GB/T 17450 技术制图 图线(GB/T 17450—1998,idt ISO 128-20:1996)

GB/T 18594 技术产品文件 字体 拉丁字母、数字和符号的 CAD 字体(GB/T 18594—2001,idt ISO 3098-5:1997)

GB/T 18686 技术制图 CAD 系统用图线的表示(GB/T 18686—2002, idt ISO 128-21:1997)

GB/T 20063(所有部分) 简图用图形符号(GB/T 20063—2006,ISO 14617:2002,IDT)

ISO 81714-1 产品技术文件用图形符号的设计 第1部分:基本规则

3 术语和定义

GB/T 17446 确立的术语和定义适用于本部分。

4 标注说明(引用 GB/T 786 的本部分)

决定遵守 GB/T 786 的本部分时,在试验报告、样本和商务文件中采用以下说明:“图形符号符合 GB/T 786.1—2009《流体传动系统及元件图形符号和回路图 第1部分:用于常规用途和数据处理的图形符号》”。

5 总则

- 5.1 元件符号的创建采用本部分规定的基本形态的符号,并考虑为创建元件符号而给出的规则。
- 5.2 大多数符号表示具有特定功能的元件或装置。部分符号表示功能或操作方法。
- 5.3 符号一般不代表元件的实际结构。

5.4 元件符号表示的是元件未受激励的状态(非工作状态)。对于没有明确定义未受激励状态(非工作状态)的元件的符号,应按本部分中列出的符号创建的特定规则给出。

注:此规则适用于在 GB/T 786.2 中给出的回路图。¹⁾

5.5 元件符号应给出所有的接口。

5.6 符号应有全部油口、气口/连接口标识以及参数或组合装置所需的空间,这些参数包括压力、流量、电气连接等。

5.7 依据 ISO 81714-1,当创建图形符号时,可以对基本形态符号进行水平翻转或旋转。

5.8 符号按如本部分和 ISO 81714-1 中定义的初始状态来表示,在不改变它们含义的前提下可以将它们水平翻转或 90° 旋转。

5.9 如果一个符号用于表示具有两个或更多主要功能的流体传动元件,并且这些功能之间相互联系,则这个符号应由实线外框包围标出(见 8.1.1)。

注 1:例如,方向控制阀控制机构的工作方式和过滤器堵塞指示不被认为是主要功能。

注 2:GB/T 786.1—1993 中的标示线为点画线,改实线外框后更加明确。

5.10 当两个或者更多元件集成为一个元件时,它们的符号应由点画线包围标出(见 8.1.3)。

5.11 本部分中的点线(非常短的虚线)用来表示邻近的基本要素或元件,在图形符号中不用。

5.12 本部分中的图形符号按照 GB/T 20063、ISO 81714-1 以及 GB/T 16901.2 中的规则来绘制。与 GB/T 20063 一致的图形符号按模数尺寸 $M=2.5\text{ mm}$,线宽为 0.25 mm 来绘制。为了缩小符号尺寸,本部分的图形符号按模数尺寸 $M=2.0\text{ mm}$,线宽 0.25 mm 来绘制。但是,对这两种模数尺寸,字符大小都应为高 2.5 mm ,线宽 0.25 mm 。可以根据需要来改变图形符号的大小以用于元件标识或样本。

5.13 字母尺寸和油/气口标识字符的尺寸应按照 GB/T 18594,字体形状 CB。





本部分中的每个图形符号按照 GB/T 20063 赋有唯一的注册号。变量位于注册号之后,用 V1、V2、V3 等表示。

对于 GB/T 20063 中仍未规定的注册号,使用基本的注册号。在流体传动领域,基本形态符号的注册号数字前用“F”来标识,应用规则的注册号数字前则由“RF”来标识。

符号的样品用“X”标识,范围 X10000~X39999 保留给流体传动技术领域。

6 液压应用实例			
6.1 阀			
6.1.1 控制机构			
	注册号	图 形	描 述
6.1.1.1	X10010 402V5 655V1 686V1 F041V1		带有分离把手和定位销的控制机构

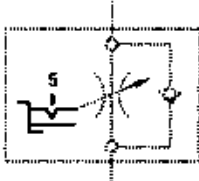

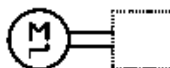
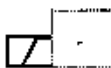
1) GB/T 786.2 正在制定中。

	注册号	图 形	描 述
6.1.1.2	X10020 402V5 711V1 201V2		具有可调行程限制装置的顶杆
6.1.1.3	X10030 402V5 655V1 684V1 F041V1		带有定位装置的推或拉控制机构
6.1.1.4	X10040 402V2 681V2 F041V1		手动锁定控制机构
6.1.1.5	X10050 402V5 685V1 F041V1		具有5个锁定位置的调节控制机构
6.1.1.6	X10060 402V5 711V1 2005V1 712V1		用作单方向行程操纵的滚轮杠杆
6.1.1.7	X10070 F019V2 211V1 402V5 F002V1		使用步进电机的控制机构
6.1.1.8	X10110 101V2 212V1		单作用电磁铁, 动作指向阀芯

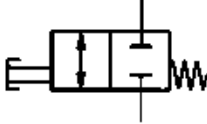
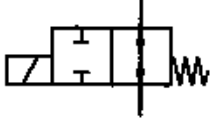
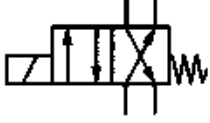
	注册号	图 形	描 述
6.1.1.9	X10120 101V2 212V2		单作用电磁铁, 动作背 离阀芯
6.1.1.10	X10130 101V2 212V4		双作用电气控制机构, 动作指向或背离阀芯
6.1.1.11	X10140 101V2 212V1 201V1		单作用电磁铁, 动作指 向阀芯, 连续控制
6.1.1.12	X10150 101V2 212V2 201V1		单作用电磁铁, 动作背 离阀芯, 连续控制
6.1.1.13	X10160 101V2 212V4 201V1		双作用电气控制机构, 动作指向或背离阀芯, 连 续控制
6.1.1.14	X10170 101V2 212V2 244V1		电气操纵的气动先导控 制机构
6.1.1.15	X10180 101V2 212V1 243V1 422V1		电气操纵的带有外部供 油的液压先导控制机构
6.1.1.16	X10190 402V1 241V1 401V1		机械反馈

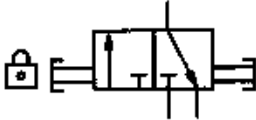
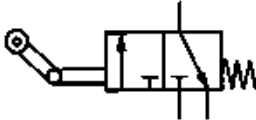
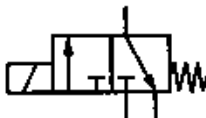
	注册号	图 形	摘 述
6.1.1.17	X10200 101V2 243V1 212V4 201V2		具有外部先导供油, 双比例电磁铁, 双向操作, 集成在同一组件, 连续工作的双先导装置的液压控制机构
6.1.2 方向控制阀			
6.1.2.1	X10210 101V7 F028V1 2172V1 2002V1 402V5 682V1 401V2		二位二通方向控制阀, 两通, 两位, 推压控制机构, 弹簧复位, 常闭
6.1.2.2	X10220 101V7 F028V1 2002V1 101V2 212V1 2172V1 401V2		二位二通方向控制阀, 两通, 两位, 电磁铁操纵, 弹簧复位, 常开
6.1.2.3	X10230 101V7 F026V1 F027V1 2002V1 101V2 212V1		二位四通方向控制阀, 电磁铁操纵, 弹簧复位

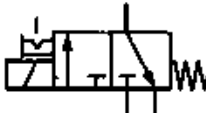
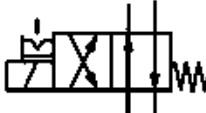

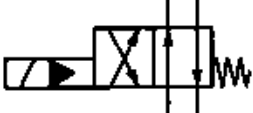
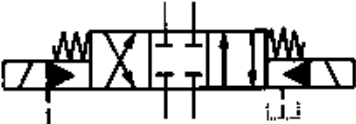
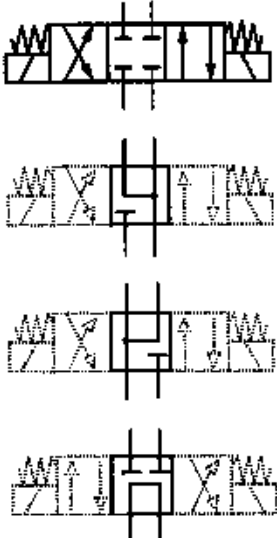

	注册号	图 形	描 述
6.1.2.4	X10260 101V7 F026V1 F027V1 2172V1 402V5 682V1 F039V1 2172V1 401V2		二位三通锁定阀
6.1.2.5	X10270 101V7 F026V1 F027V1 2172V1 2002V1 711V1 2005V1 402V5 401V2		二位三通方向控制阀， 滚轮杠杆控制，弹簧复位
6.1.2.6	X10280 101V7 F026V1 F027V1 2172V1 2002V1 101V2 212V1 401V2		二位三通方向控制阀， 电磁铁操纵，弹簧复位， 常闭

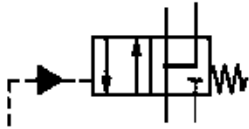
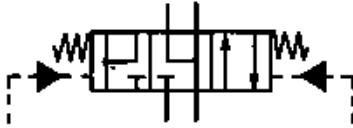
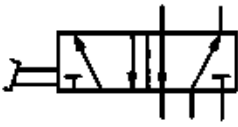
	注册号	图 形	描 述
6.1.2.7	X10290 101V7 F026V1 F027V1 2172V1 2002V1 101V2 212V1 681V2 402V2 655V1 F041V1		二位三通方向控制阀， 单电磁铁操纵，弹簧复位， 定位销式手动定位
6.1.2.8	X10320 101V7 F026V1 F027V1 2002V1 101V2 212V1 402V2		二位四通方向控制阀， 单电磁铁操纵，弹簧复位， 定位销式手动定位
6.1.2.9	X10330 101V7 F026V1 F027V1 101V2 212V1 655V1 F041V1 401V2		二位四通方向控制阀， 双电磁铁操纵，定位销式 (脉冲阀)

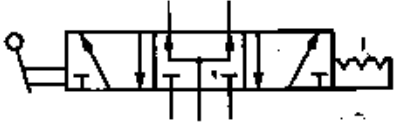
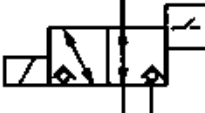
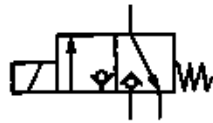

	注册号	图 形	描 述
6.1.2.10	X10350 101V7 F026V1 F027V1 2002V1 101V2 243V1 212V1 401V2		二位四通方向控制阀， 电磁铁操纵液压先导控制， 弹簧复位
6.1.2.11	X10360 101V7 F026V1 F027V1 2172V1 2002V1 212V1 401V2 F001V1		三位四通方向控制阀， 电磁铁操纵先导级和液压 操作主阀，主阀及先导级 弹簧对中，外部先导供油 和先导回油
6.1.2.12	X10370 101V7 F026V1 F027V1 2172V1 2002V1 101V2 212V1 F034V1 F031V1 501V1 401V2		三位四通方向控制阀， 弹簧对中，双电磁铁直接 操纵，不同中位机能的 类别

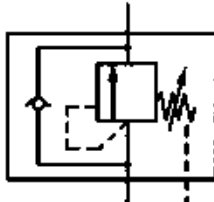
	注册号	图 形	描 述
6. 1. 2. 13	X10380 101V7 F034V1 F026V1 2172V1 2002V1 243V1 F001V1 401V2		二位四通方向控制阀， 液压控制，弹簧复位
6. 1. 2. 14	X10390 101V7 F026V1 F034V1 2172V1 2002V1 243V1 F001V1 501V1 401V2		三位四通方向控制阀， 液压控制，弹簧对中
6. 1. 2. 15	X10400 101V8 F026V1 F027V1 2172V1 402V3 690V1 401V2		二位五通方向控制阀， 踏板控制

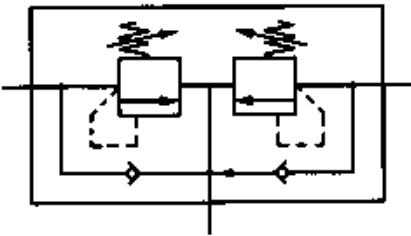
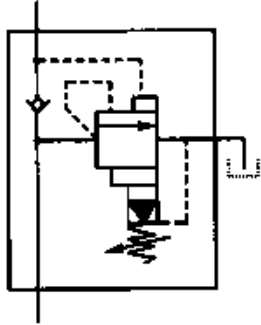

	注册号	图 形	描 述
6.1.2.16	X10420 101V8 F032V1 242V1 F025V1 F027V1 2172V1 101V2 655V1 F041V1 402V3 688V1 401V2		三位五通方向控制阀， 定位销式各位置杠杆控制
6.1.2.17	X10480 101V7 F028V1 F029V1 2162V2 2163V2 101V2 212V1 101V5 F050V1		二位三通液压电磁换向 座阀，带行程开关
6.1.2.18	X10490 101V7 F026V1 F027V1 2162V2 2163V2 2002V1 101V2 212V1 401V2		二位三通液压电磁换向 座阀

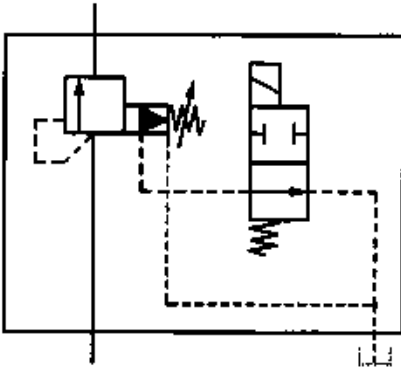
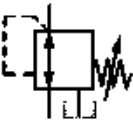
	注册号	图 形	描 述
6.1.3 压力控制阀			
6.1.3.1	X10500 101V7 F026V1 2002V1 210V2 422V2 401V2		溢流阀,直动式,开启压力由弹簧调节
6.1.3.2	X10510 101V7 F026V1 2002V1 210V2 422V2 401V2 422V1		顺序阀,手动调节设定值
6.1.3.3	X10520 101V1 101V7 F026V1 2162V1 2163V1 422V2 501V1 401V1 422V1		顺序阀,带有旁通阀
6.1.3.4	X10550 101V7 F026V1 2002V1 201V2 422V3 422V1 401V2		二通减压阀,直动式,外泄型

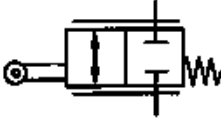
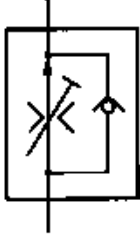
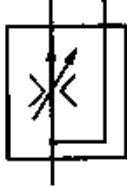
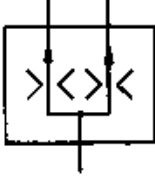
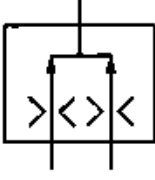

	注册号	图 形	描 述
6.1.3.5	X10560 101V7 F026V1 101V2 243V1 2002V1 201V2 422V3 401V2 422V1		二通减压阀,先导式,外泄型
6.1.3.6	X10580 101V7 101V1 F026V1 2002V1 201V2 422V2 2162V1 2163V1 501V1 401V1		防气蚀溢流阀,用来保护两条供给管道
6.1.3.7	X10590 101V7 101V1 F026V1 422V2 2177V1 101V2 243V1 2002V1 201V2 2162V1 2163V1 501V1 401V1 422V1		蓄能器充液阀,带有固定开关压差

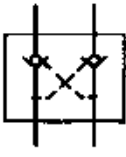
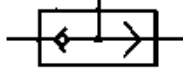

	注册号	图 形	描 述
6.1.3.8	X10600 101V7 F026V1 422V2 101V2 2002V1 201V2 2172V1 212V1 422V1 501V1 401V1		电磁溢流阀,先导式,电气操纵预设定压力
6.1.3.9	X10610 101V7 F028V1 422V4 2002V1 201V2 401V1 401V2		三通减压阀(液压)
6.1.4 流量控制阀			
6.1.4.1	X10630 401V1 2031V1 201V4		可调节流量控制阀
6.1.4.2	X10640 401V1 2031V1 201V4 2162V1 2163V1 501V1 401V1		可调节流量控制阀,单向自由流动

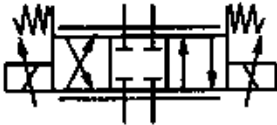
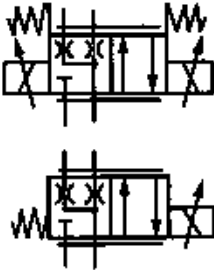
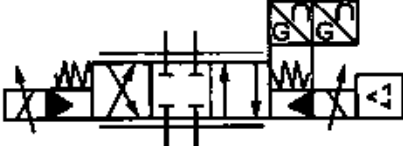
	注册号	图 形	描 述
6.1.4.3	X10650 101V7 F028V1 2172V1 RF028 2002V1 402V5 712V1		流量控制阀,滚轮杠杆操纵,弹簧复位
6.1.4.4	X10660 F022V1 F022V1 203V2 2162V1 2163V1 242V1 501V1 101V1 401V1		二通流量控制阀,可调节,带旁通阀,固定设置,单向流动,基本与黏度和压力差无关
6.1.4.5	X10670 F022V1 201V3 242V1 501V1 101V1 401V1		三通流量控制阀,可调节,将输入流量分成固定流量和剩余流量
6.1.4.6	X10680 F022V1 242V1 501V1 101V1 401V1		分流器,将输入流量分成两路输出
6.1.4.7	X10690 F022V1 242V1 501V1 101V1 401V1		集流阀,保持两路输入流量相互恒定

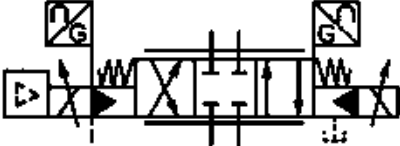

	注册号	图 形	描 述
6.1.5 单向阀和梭阀			
6.1.5.1	X10700 2162V1 2163V1 401V1		单向阀, 只能在一个方向自由流动
6.1.5.2	X10710 2162V1 2163V1 401V1 202V1		单向阀, 带有复位弹簧, 只能在一个方向流动, 常闭
6.1.5.3	X10720 2162V1 2163V1 401V1 202V1 101V1 422V1		先导式液控单向阀, 带有复位弹簧, 先导压力允许在两个方向自由流动
6.1.5.4	X10730 101V1 2162V1 2163V1 422V1 401V1		双单向阀, 先导式
6.1.5.5	X10740 101V16 2162V1 2163V1 501V2 401V1 401V2		梭阀(“或”逻辑), 压力高的入口自动与出口接通

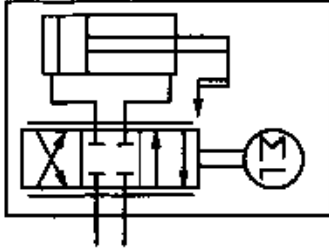
	注册号	图 形	描 述
6.1.6 比例方向控制阀			
6.1.6.1	X10760 101V7 F026V1 F027V1 2172V1 RF028 101V2 212V1 201V2 2002V1		直动式比例方向控制阀
6.1.6.2	X10770 101V7 F026V1 F027V1 F032V1 2031V2 RF028 2172V1 101V2 212V1 201V2 2002V1		比例方向控制阀,直接控制
6.1.6.3	X10780 101V7 F026V1 F027V1 RF028 101V2 243V1 212V1 201V2 2002V1 753V1 F045V1 234V1 401V2 101V5 F052V1		先导式比例方向控制阀,带主级和先导级的闭环位置控制,集成电子器件

	注册号	图 形	描 述
6.1.6.4	X10790 101V7 F026V1 F027V1 RF028 101V2 243V1 212V1 201V2 101V5 F052V1 2002V1 753V1 F045V1 234V1 2002V1 401V2		先导式伺服阀,带主级和先导级的闭环位置控制,集成电子器件,外部先导供油和回油
6.1.6.5	X10800 101V7 F026V1 F027V1 F033V1 2031V2 RF028 101V2 243V1 212V4 201V2 402V1 241V1 401V2		先导式伺服阀,先导级带双线圈电气控制机构,双向连续控制,阀芯位置机械反馈到先导装置,集成电子器件

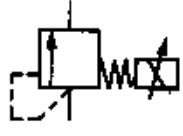
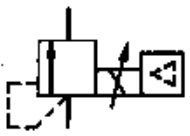
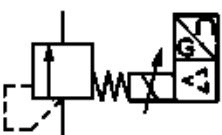

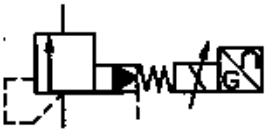
	注册号	图 形	描 述
6.1.6.6	X10810 101V7 F026V1 F027V1 2172V1 RF028 101V13 F004V1 101V14 402V1 241V1 F019V2 211V1 F002V1 402V5 101V1 401V1		电液线性执行器, 带由 步进电机驱动的伺服阀和 油缸位置机械反馈
6.1.6.7	X10820 101V7 F026V1 F027V1 2172V1 RF028 F034V1 2002V1 101V2 212V1 201V2 101V5 F052V1 753V1 F045V1 234V1		伺服阀, 内置电反馈和 集成电子器件, 带预设动 力故障位置

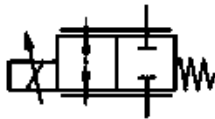
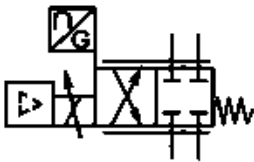
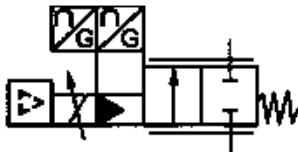

	注册号	图 形	描 述
6.1.7 比例压力控制阀			
6.1.7.1	X10830 101V7 F026V1 422V2 2002V1 101V2 212V1 201V2 401V2		比例溢流阀,直控式,通过电磁铁控制弹簧工作长度来控制液压电磁换向座阀
6.1.7.2	X10840 101V7 F026V1 422V2 101V2 212V1 201V2 401V2 101V5 F052V1 401V2		比例溢流阀,直控式,电磁力直接作用在阀芯上,集成电子器件
6.1.7.3	X10850 101V7 F026V1 422V2 2002V1 101V2 212V1 201V2 101V5 F052V1 753V1 F045V1 234V1 401V2		比例溢流阀,直控式,带电磁铁位置闭环控制,集成电子器件

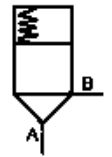
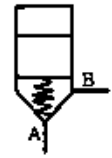
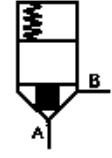
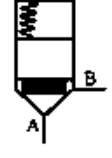
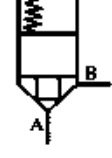
	注册号	图 形	描 述
6.1.7.4	X10860 101V7 F026V1 422V2 2002V1 101V2 212V1 201V2 401V2 243V1 753V1 F045V1 234V1		比例溢流阀,先导控制, 带电磁铁位置反馈
6.1.7.5	X10870 101V7 F028V1 422V4 101V2 243V1 2002V1 212V1 201V2 101V5 F052V1 753V1 F045V1 234V1 501V1 422V1 401V1		三通比例减压阀,带电 磁铁闭环位置控制和集成 式电子放大器
6.1.7.6	X10880 101V7 F026V1 101V2 243V1 212V1 201V2 101V5 F052V1 422V2 422V1 401V2		比例溢流阀,先导式,带 电子放大器和附加先导 级,以实现手动压力调节 或最高压力溢流功能

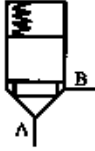
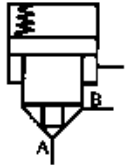
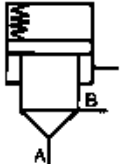
	注册号	图 形	描 述
6.1.8 比例流量控制阀			
6.1.8.1	X10890 101V7 F028V1 2172V1 RF028 2002V1 101V2 212V1 201V2 401V2		比例流量控制阀, 直控式
6.1.8.2	X10900 101V7 F027V1 2172V1 RF028 2002V1 101V2 212V1 201V2 101V5 F052V1 753V1 F045V1 234V1 401V2		比例流量控制阀, 直控式, 带电磁铁闭环位置控制和集成式电子放大器
6.1.8.3	X10910 101V7 2172V2 F026V1 2172V1 RF028 2002V1 101V2 243V1 212V1 201V2 753V1 F045V1 234V1 101V5 F052V1 401V2		比例流量控制阀, 先导式, 带主级和先导级的位置控制和电子放大器

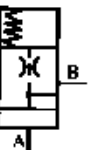
	注册号	图 形	描 述
6.1.8.4	X10920 201V3 242V1 101V2 212V4 201V2 401V1		流量控制阀,用双线圈比例电磁铁控制,节流孔可变,特性不受黏度变化的影响
6.1.9 二通盖板式插装阀			
6.1.9.1	X10930 F010V1 101V1 2002V2 401V2		压力控制和方向控制插装阀插件,座阀结构,面积 1:1
6.1.9.2	X10940 F010V1 101V1 2002V2 401V2		压力控制和方向控制插装阀插件,座阀结构,常开,面积比 1:1
6.1.9.3	X10950 F010V1 F011V1 2002V2 401V2		方向控制插装阀插件,带节流端的座阀结构,面积比例 ≤ 0.7
6.1.9.4	X10960 F010V1 F012V1 2002V2 401V2		方向控制插装阀插件,带节流端的座阀结构,面积比例 > 0.7
6.1.9.5	X10970 F010V1 F011V1 2002V2 401V2		方向控制插装阀插件,座阀结构,面积比例 ≤ 0.7

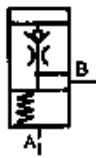
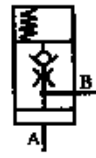
	注册号	图 形	描 述
6.1.9.6	X10980 F010V1 F012V1 2002V2 401V2		方向控制插装阀插件， 座阀结构，面积比例 >0.7
6.1.9.7	X10990 F013V1 F014V1 2002V2 401V2		主动控制的方向控制插 装阀插件，座阀结构，由先 导压力打开
6.1.9.8	X11000 F013V1 F015V1 2002V2 401V2		主动控制插件，B端无 面积差
6.1.9.9	X11010 F010V1 F011V1 2002V2 2031V2 401V2 RF034		方向控制阀插件，单向 流动，座阀结构，内部先导 供油，带可替换的节流孔 (节流器)
6.1.9.10	X11020 101V10 101V11 2002V2 2031V2 501V1 401V1		带溢流和限制保护功能 的阀芯插件，滑阀结构， 常闭

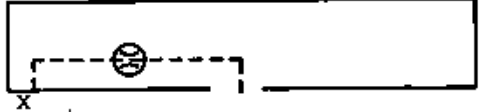
	注册号	图 形	描 述
6.1.9.11	X11030 101V10 101V11 2002V2 2031V2 501V1 2162V2 6163V2 401V1 422V1		减压插装阀插件,滑阀结构,常闭,带集成的单向阀
6.1.9.12	X11040 101V10 101V11 2002V2 2031V2 501V1 2162V2 6163V2 401V1 422V1		减压插装阀插件,滑阀结构,常开,带集成的单向阀
6.1.9.13	X11050 F016V1		无端口控制盖
6.1.9.14	X11060 F016V1 2031V2 RF034 422V1		带先导端口的控制盖

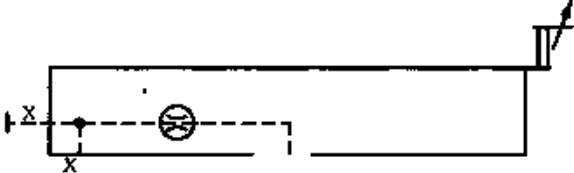
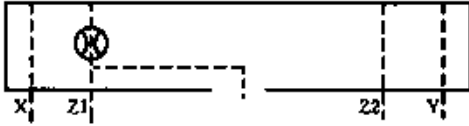
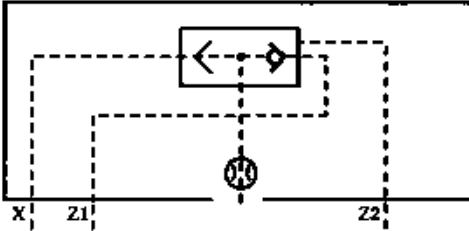
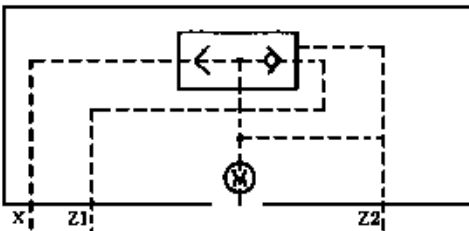
	注册号	图 形	描 述
6.1.9.15	X11070 F016V1 2031V2 RF034 2172V1 F020V1 201V1 501V1 422V1 401V1		带先导端口的控制盖，带可调行程限位器和遥控端口
6.1.9.16	X11080 F016V1 2031V2 RF034 501V1 422V1		可安装附加元件的控制盖
6.1.9.17	X11090 F016V1 2031V2 RF034 101V16 2162V1 2163V1 501V2 401V1 422V1		带液压控制梭阀的控制盖
6.1.9.18	X11100 F016V1 2031V2 RF034 101V16 2162V1 2163V1 501V2 401V1 422V1		带梭阀的控制盖

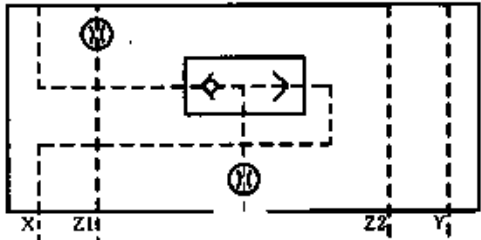
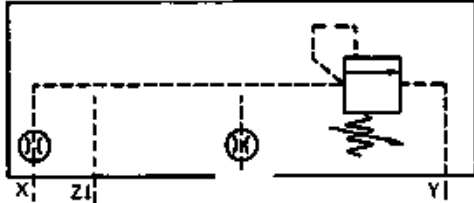
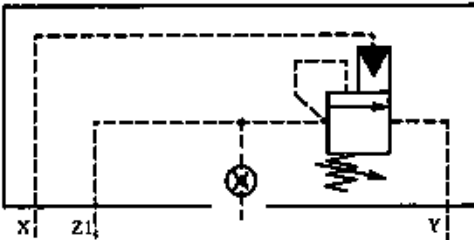

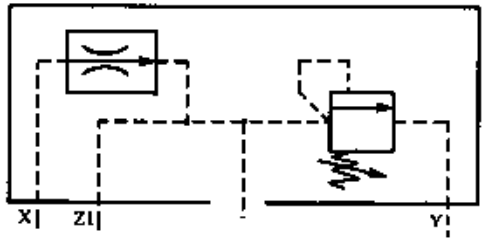
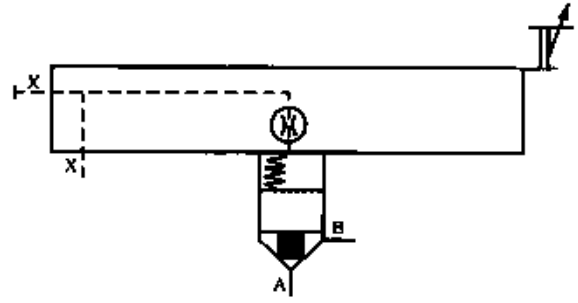
	注册号	图 形	描 述
6. 1. 9. 19	X11110 F016V1 2031V2 RF034 101V16 2162V1 2163V1 501V2 401V1 422V1		可安装附加元件,带梭阀的控制盖
6. 1. 9. 20	X11120 F016V1 2031V2 RF034 501V1 101V7 F026V1 2002V1 210V2 422V2 401V2		带溢流功能的控制盖
6. 1. 9. 21	X11130 F016V1 2031V2 RF034 501V1 101V7 F026V1 2002V1 210V2 422V2 401V2 101V2 243V1		带溢流功能和液压卸载的控制盖

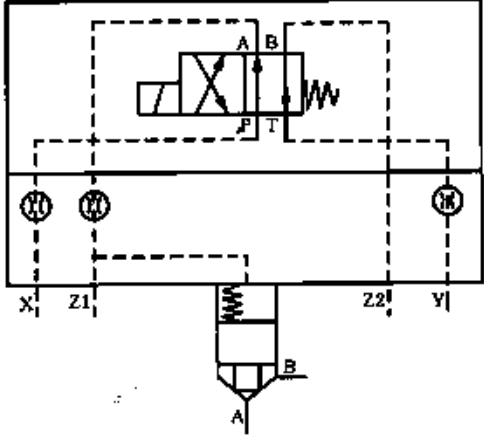
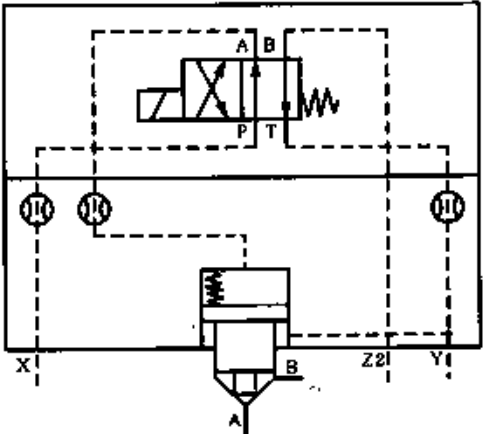

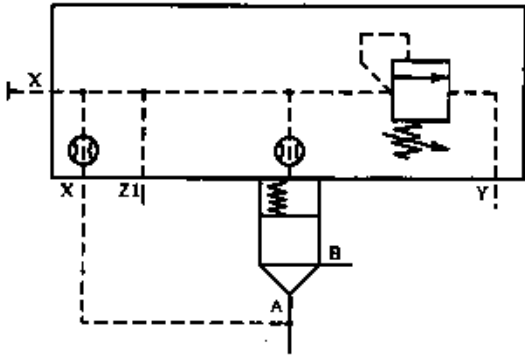
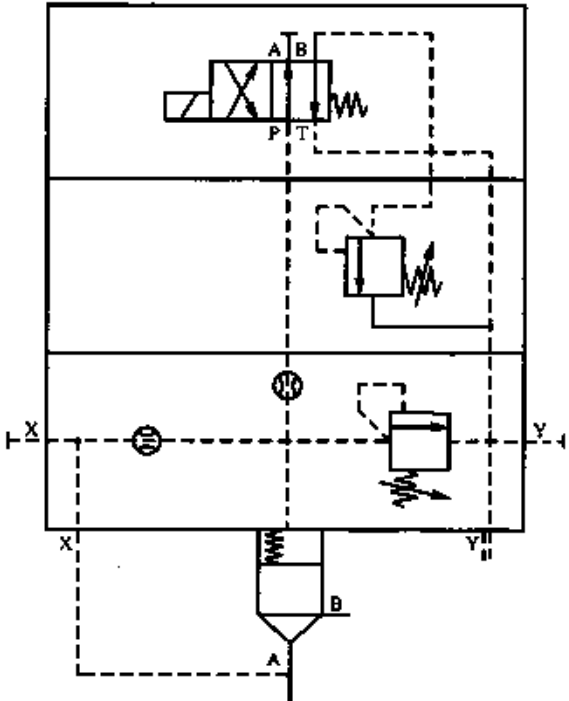
	注册号	图 形	描 述
6. 1. 9. 22	X11140 F016V1 2031V2 RF034 501V1 101V7 F026V1 2002V1 210V2 422V2 401V2 2031V1 242V1 401V1		带溢流功能的控制盖， 用流量控制阀来限制先导 级流量
6. 1. 9. 23	X11150 F016V1 2031V2 RF034 2172V1 F020V1 201V1 501V1 422V1 401V1 F010V1 F011V1 2002V2 401V2		带行程限制器的二通插 装阀

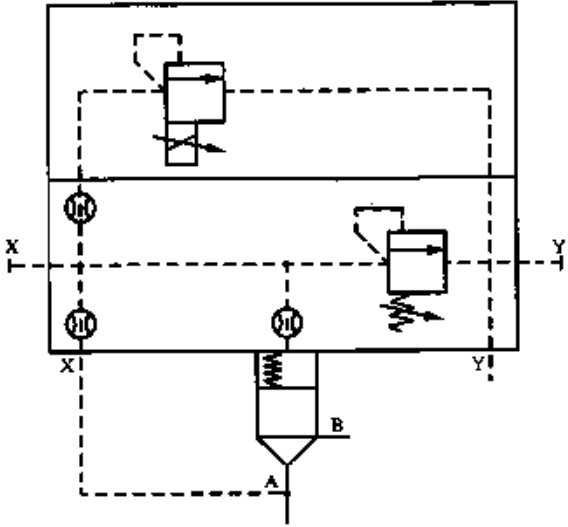
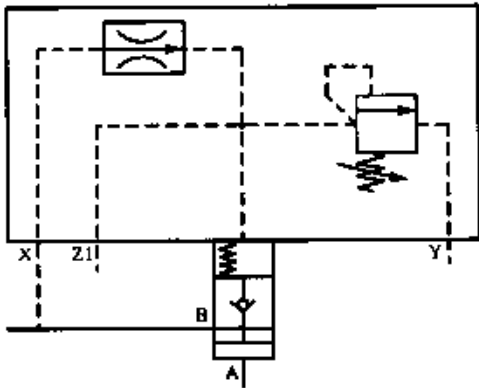
	注册号	图 形	描 述
6. 1. 9. 24	X11160 101V7 F026V1 F027V1 101V2 212V1 2002V1 F016V1 2031V2 RF034 501V1 422V1 F010V1 F011V1 2002V2 401V2		带方向控制阀的二通插装阀
6. 1. 9. 25	X11170 101V7 F026V1 F027V1 101V2 212V1 2002V1 F016V1 2031V2 RF034 422V1 F013V1 F015V1 2002V2 401V2		主动控制,带方向控制阀的二通插装阀

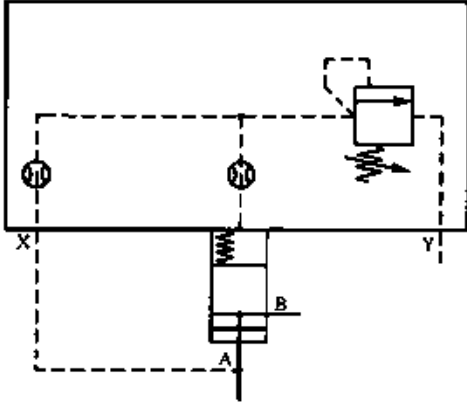
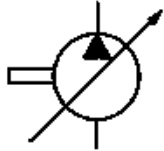
	注册号	图 形	描 述
6. 1. 9. 26	X11180 F010V1 101V1 2002V2 401V2 F016V1 2031V2 RF034 501V1 101V7 F026V1 2002V1 210V2 422V2 401V2		带溢流功能的二通插装阀
6. 1. 9. 27	X11190 101V7 F026V1 F027V1 2172V1 2002V1 101V2 201V2 F016V1 2031V2 RF034 501V1 422V1 F010V1 101V1 2002V2 401V2		带溢流功能和可选第二级压力的二通插装阀

	注册号	图 形	描 述
6.1.9.28	X11200 101V7 F026V1 F027V1 2172V1 2002V1 101V2 201V2 F016V1 2031V2 RF034 501V1 422V1 F010V1 101V1 2002V2 401V2		带比例压力调节和手动 最高压力溢流功能的二通 插装阀
6.1.9.29	X11210 F016V1 2031V2 RF034 501V1 101V7 F026V1 2002V1 210V2 422V2 401V2 2031V1 242V1 101V10 101V11 2002V2 501V1 2162V2 6163V2 401V1 422V1		高压控制、带先导流量 控制阀的减压功能的二通 插装阀

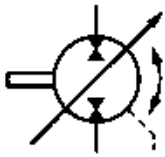
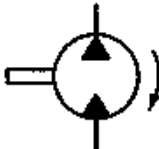
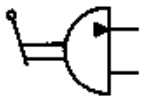
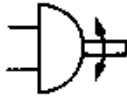

	注册号	图 形	描 述
6.1.9.30	X11220 F016V1 2031V2 RF034 501V1 101V7 F026V1 2002V1 210V2 422V2 401V2 101V10 101V11 2002V2 501V1 401V1		低压控制、减压功能的 二通插装阀
6.2 泵和马达			
6.2.1	X11230 2065V1 243V1 F017V1 201V5 401V2		变量泵
6.2.2	X11240 2065V1 243V1 F017V1 201V5 401V2 255V1 422V1		双向流动,带外泄油路 单向旋转的变量泵

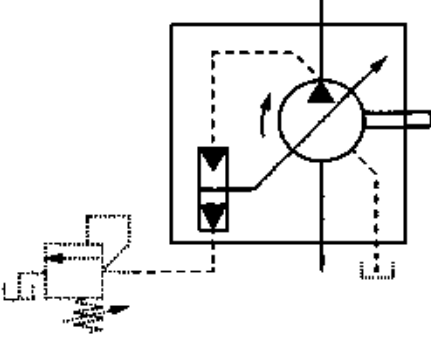
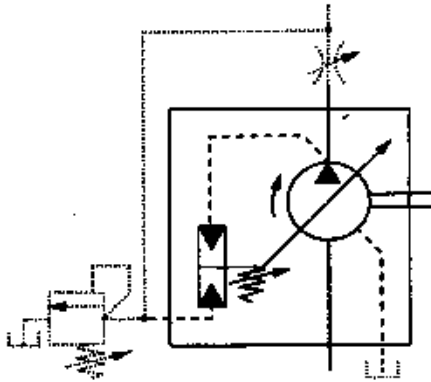
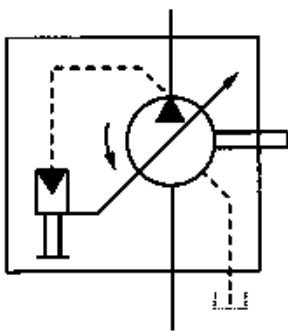
	注册号	图 形	描 述
6.2.3	X11250 2065V1 243V2 F017V1 201V5 401V2 256Y1		双向变量泵或马达单元,双向流动,带外泄油路,双向旋转
6.2.4	X11260 2065V1 243V1 F017V1 401V2 255V1 422V1		单向旋转的定量泵或马达
6.2.5	X11270 F003V1 243V2 402V3 688V1 401V2		操纵杆控制,限制转盘角度的泵
6.2.6	X11280 F003V1 256V1 F017V1 401V2		限制摆动角度,双向流动的摆动执行器或旋转驱动
6.2.7	X11290 F003V1 256V1 F017V1 401V2 2002V1		单作用的半摆动执行器或旋转驱动

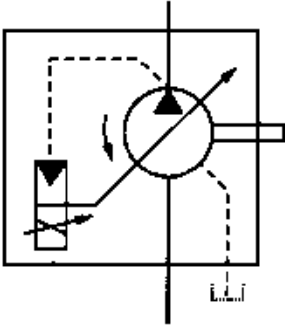
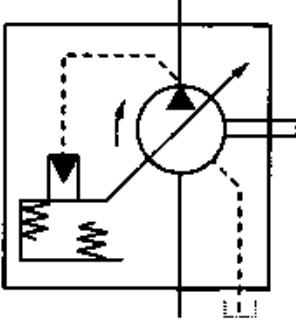

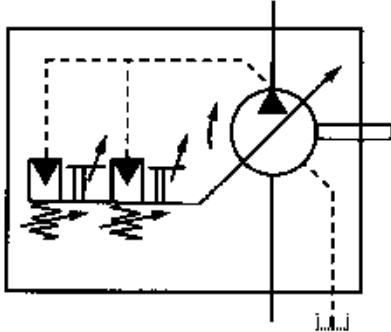
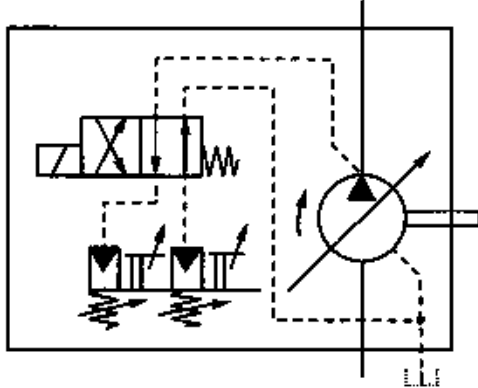
	注册号	图 形	描 述
6.2.8	X11300 2065V1 243V1 F017V1 201V5 401V2 255V1 422V1 101V2 101V1 243V1		变量泵, 先导控制, 带压力补偿, 单向旋转, 带外泄油路
6.2.9	X11310 2065V1 243V1 F017V1 201V5 401V2 255V1 422V1 101V2 101V1 243V1 2002V1 201V2		带复合压力或流量控制(负载敏感型)变量泵, 单向驱动, 带外泄油路
6.2.10	X11320 2065V1 243V1 F017V1 201V5 401V2 255V2 422V1 101V2 101V1 243V1 402V5 681V2		机械或液压伺服控制的变量泵

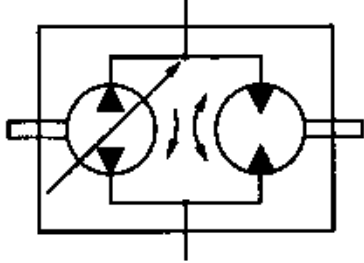
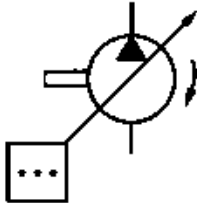
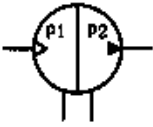

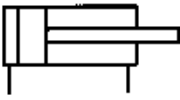
	注册号	图 形	描 述
6.2.11	X11330 2065V1 243V1 F017V1 201V5 401V2 255V2 422V1 101V2 101V1 243V1 212V1 210V2		电液伺服控制的变量液 压泵
6.2.12	X11340 2065V1 243V1 F017V1 201V5 401V2 255V2 422V1 101V2 101V1 243V1 2002V1 401V1		恒功率控制的变量泵

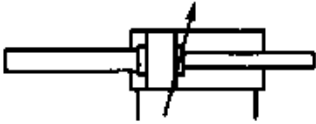
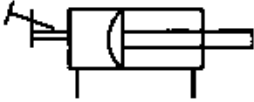
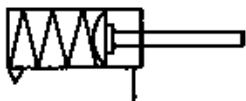
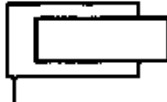
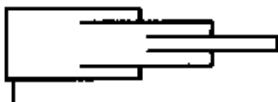

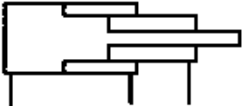
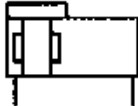
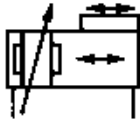

	注册号	图 形	描 述
6.2.13	X11350 2065V1 243V1 F017V1 201V5 401V2 255V1 422V1 101V2 101V1 243V1 2002V1 201V2 F020V1 201V1 501V1		带两级压力或流量控制的 变量泵,内部先导操纵
6.2.14	X11360 2065V1 243V1 F017V1 201V5 401V2 255V1 422V1 101V2 101V1 243V1 2002V1 201V2 F020V1 201V1 501V1 101V7 F026V1 F027V1		带两级压力控制元件的 变量泵,电气转换

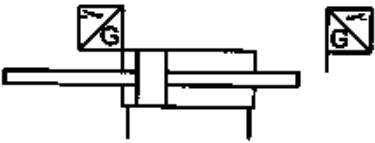
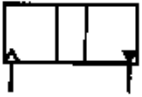
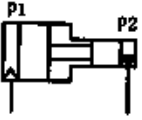

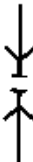



	注册号	图 形	描 述
6.2.15	X11370 2065V1 243V1 F017V1 201V5 401V2 255V1 422V1 501V1 101V1 401V1		静液传动(简化表达)驱动单元,由一个能反转、带单输入旋转方向的变量泵和一个带双输出旋转方向的定量马达组成
6.2.16	X11380 2065V1 243V1 F017V1 201V5 401V2 101V7		表现出控制和调节元件的变量泵,箭头表示调节能力可扩展,控制机构和元件可以在箭头任意一边连接 *** 没有指定复杂控制器
6.2.17	X11430 2065V1 243V2 244V2 401V2		连续增压器,将气体压力 p_1 转换为较高的液体压力 p_2
6.3 缸			
6.3.1	X11440 101V13 2002V3 101V14 F004V1 401V2		单作用单杆缸,靠弹簧力返回行程,弹簧腔带连接油口
6.3.2	X11450 101V13 101V14 F004V1 401V2		双作用单杆缸

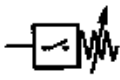



	注册号	图 形	描 述
6.3.3	X11460 101V13 101V14 F004V1 F004V2 101V19 201V7 401V2		双作用双杆缸, 活塞杆直径不同, 双侧缓冲, 右侧带调节
6.3.4	X11470 101V13 F006V1 F004V1 F003V1 201V1 401V2		带行程限制器的双作用膜片缸
6.3.5	X11480 101V13 F004V1 F006V1 101V19 2002V3 2174V1 401V2		活塞杆终端带缓冲的单作用膜片缸, 排气口不连接
6.3.6	X11490 101V22 101V18 401V2		单作用缸, 柱塞缸
6.3.7	X11500 101V22 F004V1 F004V3 401V2		单作用伸缩缸



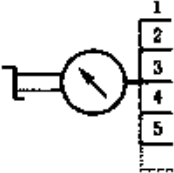

	注册号	图 形	描 述
6.3.8	X11510 101V22 F005V1 F008V2 401V2		双作用伸缩缸
6.3.9	X11520 101V13 101V14 101V19 101V20		双作用带状无杆缸, 活塞两端带终点位置缓冲
6.3.10	X11530 101V13 101V14 101V19 101V20 201V7 245V1 401V2		双作用缆绳式无杆缸, 活塞两端带可调节终点位置缓冲
6.3.11	X11540 101V13 101V14 753V1 F045V1 F048V1 326V1 401V2		双作用磁性无杆缸, 仅右边终端位置切换
6.3.12	X11550 101V13 101V14 F004V1 655V1 F041V1 401V2		行程两端定位的双作用缸





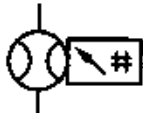

	注册号	图 形	描 述
6.3.13	X11560 101V13 101V14 F004V1 753V1 F045V1 F048V1 401V2		双杆双作用缸,左终点带内部限位开关,内部机械控制,右终点有外部限位开关,由活塞杆触发
6.3.14	X11580 101V13 101V14 243V2 244V2 401V2		单作用压力介质转换器,将气体压力转换为等值的液体压力,反之亦然
6.3.15	X11590 F007V1 F008V1 243V2 244V2 401V2		单作用增压器,将气体压力 p_1 转换为更高的液体压力 p_2
6.4 附件			
6.4.1 连接和管接头			
6.4.1.1	X11670 501V1 452V1		软管总成
6.4.1.2	X11680 F036V1 RF049		三通旋转接头
6.4.1.3	X11690 2162V1 2172V1		不带单向阀的快换接头,断开状态

	注册号	图 形	描 述
6.4.1.4	X11700 2162V1 2163V1 2172V1		带单向阀的快换接头, 断开状态
6.4.1.5	X11710 2162V1 2163V1 2172V1		带两个单向阀的快换接头, 断开状态
6.4.1.6	X11720 2162V1 2172V1		不带单向阀的快换接头, 连接状态
6.4.1.7	X11730 2162V1 2163V1 2172V1		带一个单向阀的快插管接头, 连接状态
6.4.1.8	X11740 2162V1 2163V1 2172V1		带两个单向阀的快插管接头, 连接状态
6.4.2 电气装置			
6.4.2.1	X11750 101V5 F017V1 2002V1 201V2 401V2		可调节的机械电子压力继电器



	注册号	图 形	描 述
6.4.2.2	X11760 753V1 F045V1 F048V1 201V1 401V1 401V2		输出开关信号、可电子调节的压力转换器
6.4.2.3	X11770 753V1 F045V1 234V1 401V2		模拟信号输出压力传感器
6.4.3 测量仪和指示器			
6.4.3.1	X11790 101V6 148V1 F056V1		光学指示器
6.4.3.2	X11800 101V6 235V1 148V1		数字式指示器
6.4.3.3	X11810 101V6 148V1 F057V1		声音指示器
6.4.3.4	X11820 F002V1 148V1 401V2		压力测量单元(压力表)



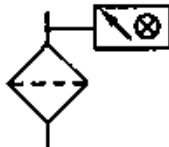

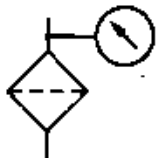
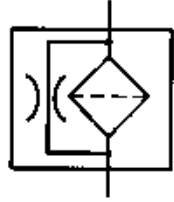
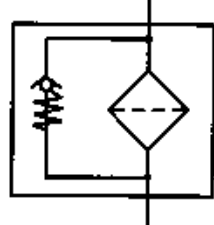
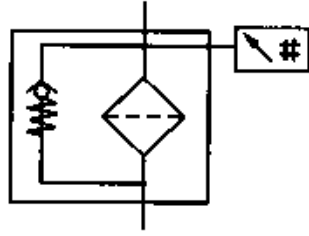
	注册号	图 形	描 述
6.4.3.5	X11830 F002V1 148V1 401V2		压差计
6.4.3.6	X11840 F002V1 148V1 402V5 685V1 401V2		带选择功能的压力表
6.4.3.7	X11850 F002V1 F055V1 401V2		温度计
6.4.3.8	X11860 F002V1 F055V1 401V2 F049V1 201V1		可调电气常闭触点温度计(接点温度计)
6.4.3.9	X11870 F002V1 1103V1 F058V1 401V2		液位指示器(液位计)
6.4.3.10	X11880 F002V1 1103V1 F058V1 401V2 F049V1		四常闭触点液位开关

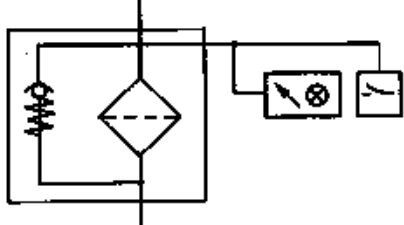
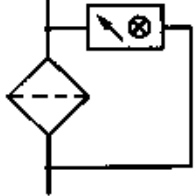
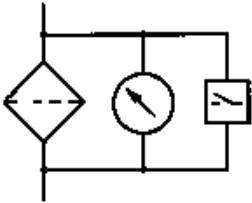



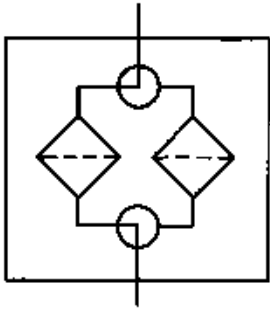

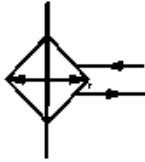
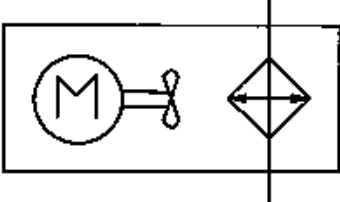
	注册号	图 形	描 述
6.4.3.11	X11890 F002V1 1103V1 F058V1 401V2 148V1 101V6 235V1 234V1 F045V1 753V1		模拟量输出数字式电气 液位监控器
6.4.3.12	X11900 F002V1 F054V1 401V2		流量指示器
6.4.3.13	X11910 F002V1 F054V1 401V2		流量计
6.4.3.14	X11920 F002V1 F054V1 401V2 101V6 235V1 148V1		数字式流量计
6.4.3.15	X11930 F002V1 401V2 F025V1		转速仪
6.4.3.16	X11940 F002V1 401V2 F024V1		转矩仪



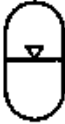

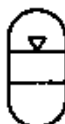
	注册号	图 形	描 述
6.4.3.17	X11950 101V6 F059V1 F050V1		开关式定时器
6.4.3.18	X11960 101V5 F060V1		计数器
6.4.3.19	X11970 101V1 422V1 242V1 2061V1 401V1		直通式颗粒计数器
6.4.4 过滤器与分离器			
6.4.4.1	X11980 101V15 F061V1 401V2		过滤器
6.4.4.2	X11990 101V15 F061V1 244V2 401V2		油箱通气过滤器
6.4.4.3	X12000 101V15 F061V1 326V1 401V2		带附属磁性滤芯的过滤器
6.4.4.4	X12010 101V15 F061V1 101V6 148V1 F056V1 401V2		带光学阻塞指示器的过滤器

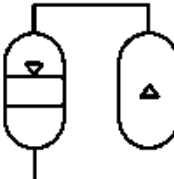

	注册号	图 形	描 述
6.4.4.5	X12020 101V15 F061V1 F002V1 148V1 422V1 401V2		带压力表的过滤器
6.4.4.6	X12030 101V15 F061V1 2031V1 501V1 401V1		带旁路节流的过滤器
6.4.4.7	X12040 101V15 F061V1 2002V1 2162V1 2163V1 501V1 401V1		带旁路单向阀的过滤器
6.4.4.8	X12050 101V15 F061V1 2002V1 2162V1 2163V1 501V1 101V6 148V1 235V1 401V1		带旁路单向阀和数字显示器的过滤器

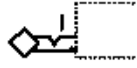

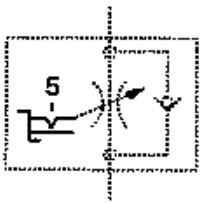
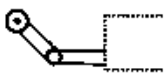

	注册号	图 形	描 述
6.4.4.9	X12060 101V15 F061V1 2002V1 2162V1 2163V1 501V1 101V6 148V1 235V1 401V1 101V5 F050V1 422V1		带旁路单向阀、光学阻塞指示器与电气触点的过滤器
6.4.4.10	X12070 101V15 F061V1 101V6 148V1 F056V1 401V2		带光学压差指示器的过滤器
6.4.4.11	X12080 101V15 F061V1 F002V1 148V1 422V1 401V2 101V5 F050V1		带压差指示器与电气触点的过滤器
6.4.4.12	X12090 101V15 F066V1 401V2		离心式分离器

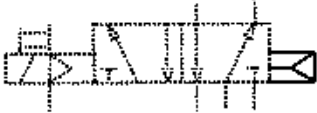
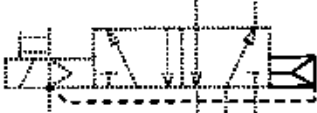
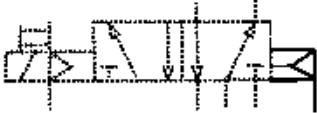
	注册号	图 形	描 述
6.4.4.13	X12170 101V15 422V1 F037V1 401V1		带手动切换功能的双过滤器
6.4.5 热交换器			
6.4.5.1	X12260 101V15 F067V1 401V1		不带冷却液流道指示的冷却器
6.4.5.2	X12270 101V15 F067V1 242V1 401V1		液体冷却的冷却器
6.4.5.3	X12280 101V15 F067V1 2065V1 F019V1 F072V1 402V5 401V2		电动风扇冷却的冷却器
6.4.5.4	X12290 101V15 F067V1 401V1		加热器

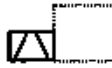
	注册号	图 形	描 述
6.4.5.5	X12300 101V15 F067V1 401V1		温度调节器
6.4.6 蓄能器(压力容器,气瓶)			
6.4.6.1	X12320 F069V1 244V2 401V1		隔膜式充气蓄能器(隔膜式蓄能器)
6.4.6.2	X12330 F069V1 F006V1 244V2		破裂式充气蓄能器(破裂式蓄能器)
6.4.6.3	X12340 F069V1 101V14 244V2		活塞式充气蓄能器(活塞式蓄能器)
6.4.6.4	X12350 F069V1 244V2		气瓶
6.4.6.5	X12360 F069V1 101V14 244V2 401V1		带下游气瓶的活塞式蓄能器
6.4.7 润滑点			
6.4.7.1	X12440 101V21		润滑点

7 气动应用实例			
7.1 阀			
7.1.1 控制机构			
	注册号	图 形	描 述
7.1.1.1	X10010 402V5 655V1 686V1 F041V1		带有分离把手和定位销的控制机构
7.1.1.2	X10020 402V5 711V1 201V2		具有可调行程限制装置的柱塞
7.1.1.3	X10030 402V5 655V1 684V1 F041V1		带有定位装置的推或拉控制机构
7.1.1.4	X10040 402V2 681V2 F041V1		手动锁定控制机构
7.1.1.5	X10050 402V5 685V1 F041V1		具有 5 个锁定位置的调节控制机构
7.1.1.6	X10060 402V5 711V1 2005V1 712V1		单方向行程操纵的滚轮手柄

	注册号	图 形	描 述
7.1.1.7	X10070 F019V2 211V1 402V5 F002V1		用步进电机的控制机构
7.1.1.8	X10080 101V2 244V1 401V1		气压复位, 从阀进气口提供内部压力
7.1.1.9	X10090 101V2 244V1 422V1 401V1		气压复位, 从先导口提供内部压力 注: 为更易理解, 图中标识出外部先导线
7.1.1.10	X10100 101V2 244V1 401V1		气压复位, 外部压力源
7.1.1.11	X10110 101V2 212V1		单作用电磁铁, 动作指向阀芯
7.1.1.12	X10120 101V2 212V2		单作用电磁铁, 动作背离阀芯
7.1.1.13	X10130 101V2 212V4		双作用电气控制机构, 动作指向或背离阀芯

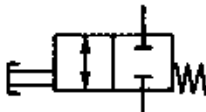
	注册号	图 形	描 述
7.1.1.14	X10140 101V2 212V1 201V1		单作用电磁铁, 动作指向阀芯, 连续控制
7.1.1.15	X10150 101V2 212V2 201V1		单作用电磁铁, 动作背离阀芯, 连续控制
7.1.1.16	X10160 101V2 212V4 201V1		双作用电气控制机构, 动作指向或背离阀芯, 连续控制
7.1.1.17	X10170 101V2 212V2 244V1		电气操纵的气动先导控制机构
7.1.2 方向控制阀			
7.1.2.1	X10210 101V7 F028V1 2172V1 2002V1 402V5 682V1 401V2		二位二通方向控制阀, 两通, 两位, 推压控制机构, 弹簧复位, 常闭

	注册号	图 形	描 述
7.1.2.2	X10220 101V7 F028V1 2002V1 101V2 212V1 2172V1 401V2		二位二通方向控制阀， 两通，两位，电磁铁操纵， 弹簧复位，常开
7.1.2.3	X10230 101V7 F026V1 F027V1 2002V1 101V2 212V1		二位四通方向控制阀， 电磁铁操纵，弹簧复位
7.1.2.4	X10240 101V7 F026V1 F021V1 401V1 101V2 212V1 2002V1 244V1		气动软启动阀，电磁铁 操纵内部先导控制
7.1.2.5	X10250 101V1 101V7 2172V1 F026V1 101V2 244V1 2031V1 201V4 501V1		延时控制气动阀，其入 口接入一个系统，使得气 体低速流入直至达到预设 压力才使阀口全开

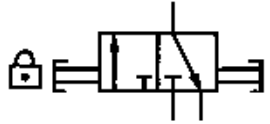
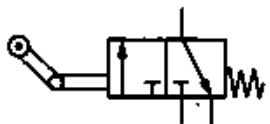
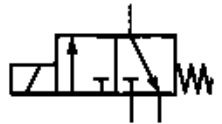
	注册号	图 形	描 述
7.1.2.6	X10260 101V7 F026V1 F027V1 2172V1 402V5 682V1 F039V1 2172V1 401V2		二位三通锁定阀
7.1.2.7	X10270 101V7 F026V1 F027V1 2172V1 2002V1 711V1 2005V1 402V5 401V2		二位三通方向控制阀，滚轮杠杆控制，弹簧复位
7.1.2.8	X10280 101V7 F026V1 F027V1 2172V1 2002V1 101V2 212V1 401V2		二位三通方向控制阀，电磁铁操纵，弹簧复位，常闭

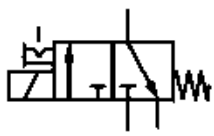
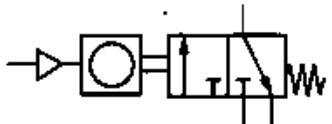
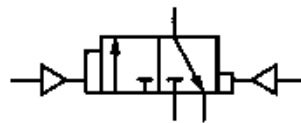
	注册号	图 形	描 述
7.1.2.9	X10290 101V7 F026V1 F027V1 2172V1 2002V1 101V2 212V1 681V2 402V2 655V1 F041V1		二位三通方向控制阀， 单作业电磁铁操纵，弹簧 复位，定位销式手动定位
7.1.2.10	X10300 101V7 F026V1 F027V1 2172V1 2002V1 401V2 402V2 101V5 F060V1 244V1		带气动输出信号的脉冲 计数器
7.1.2.11	X10310 101V7 F026V1 F027V1 2172V1 2177V1 244V1 401V1 401V2		二位三通方向控制阀， 差动先导控制

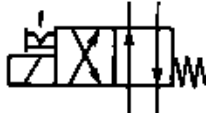
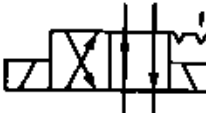
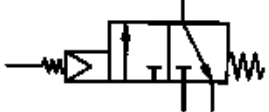

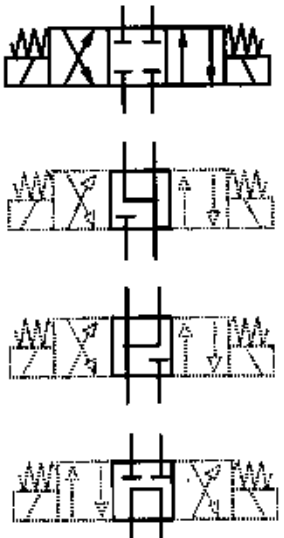
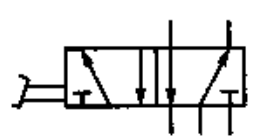
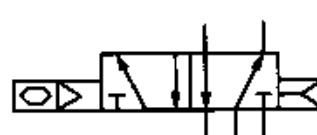
	注册号	图 形	描 述
7.1.2.12	X10320 101V7 F026V1 F027V1 2002V1 101V2 212V1 402V2		二位四通方向控制阀， 单作用电磁铁操纵，弹簧 复位，定位销式手动定位
7.1.2.13	X10330 101V7 F026V1 F027V1 101V2 212V1 655V1 F041V1 401V2		二位四通方向控制阀， 双作用电磁铁操纵，定位 销式(脉冲阀)
7.1.2.14	X10340 101V7 F026V1 F027V1 2172V1 101V2 244V1 F042V1 2002V1 401V2		二位三通方向控制阀， 气动先导式控制和扭力 杆，弹簧复位

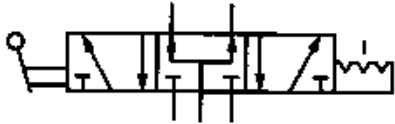
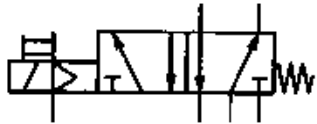
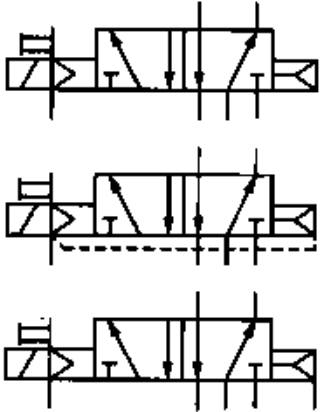

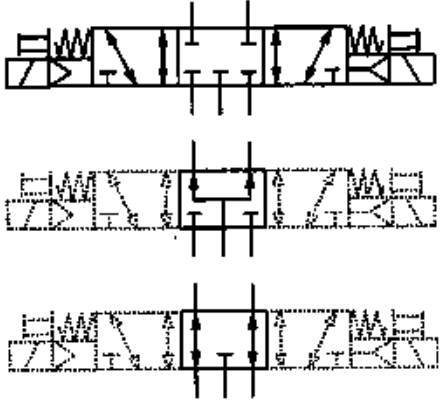
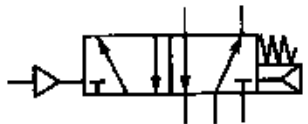
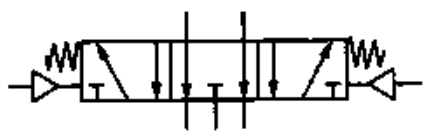
	注册号	图 形	描 述
7.1.2.15	X10370 101V7 F026V1 F027V1 2172V1 2002V1 101V2 212V1 F034V1 F031V1 501V1 401V2		三位四通方向控制阀， 弹簧对中，双作用电磁铁 直接操纵，不同中位机能 的类别
7.1.2.16	X10400 101V8 F026V1 F027V1 2172V1 402V3 690V1 401V2		二位五通方向控制阀， 踏板控制
7.1.2.17	X10410 101V8 F026V1 F027V1 2172V1 101V2 244V1 401V1 F047V1 401V2		二位五通气动方向控制 阀，先导式压电控制，气压 复位

	注册号	图 形	描 述
7.1.2.18	X10420 101V8 F032V1 242V1 F026V1 F027V1 2172V1 101V2 655V1 F041V1 402V3 688V1 401V2		三位五通方向控制阀， 手动拉杆控制，位置锁定
7.1.2.19	X10430 101V8 F026V1 F027V1 2172V1 2002V1 101V2 244V1 212V1 402V2 F041V1 401V2		二位五通气动方向控制 阀，单作用电磁铁，外部先 导供气，手动操纵，弹簧 复位
7.1.2.20	X10440 101V8 F026V1 F027V1 2172V1 101V2 244V1 212V1 402V1 681V1 401V1 401V2 422V1		二位五通气动方向控制 阀，电磁铁先导控制，外部 先导供气，气压复位，手动 辅助控制。 气压复位供压具有如下 可能： 一从阀进气口提供内部 压力； 一从先导口提供内部 压力； 一外部压力源

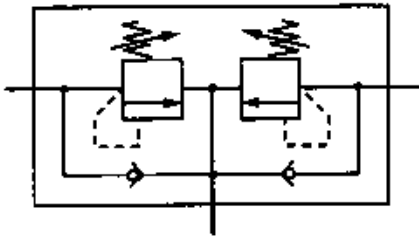
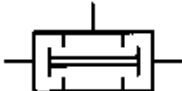
	注册号	图 形	描 述
7. 1. 2. 21	X10450 101V8 F028V1 F029V1 2172V1 101V2 244V1 2002V1 402V2 681V2 F032V1 242V1 401V2		不同中位流路的三位五通气动方向控制阀, 两侧电磁铁与内部先导控制和手动操纵控制。弹簧复位至中位
7. 1. 2. 22	X10460 101V8 F026V1 F027V1 2172V1 101V2 2002V1 243V1 401V1 401V2		二位五通直动式气动方向控制阀, 机械弹簧与气压复位
7. 1. 2. 23	X10470 101V8 F026V1 V027V1 2172V1 2002V1 243V1 401V1 401V2		三位五通直动式气动方向控制阀, 弹簧对中, 中位时两出口都排气

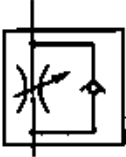
	注册号	图 形	描 述
7.1.3 压力控制阀			
7.1.3.1	X10500 101V7 F026V1 2002V1 210V2 422V2 401V2		弹簧调节开启压力的直 动式溢流阀
7.1.3.2	X10530 101V7 F026V1 2002V1 201V2 244V1 422V1 401V2		外部控制的顺序阀
7.1.3.3	X10540 101V7 F028V1 2002V1 201V2 422V4 2174V1 401V2		内部流向可逆调压阀
7.1.3.4	X10570 101V7 F026V1 101V2 244V1 422V4 401V2 2174V1		调压阀,远程先导可调, 溢流,只能向前流动

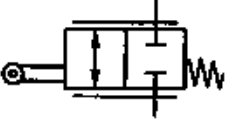
	注册号	图 形	描 述
7.1.3.5	X10580 101V7 101V1 F026V1 2002V1 201V2 422V2 2162V1 2163V1 501V1 401V1		用来保护两条供给管道的防气蚀溢流阀
7.1.3.6	X10620 101V16 F040V1 401V1 401V2		双压阀(“与”逻辑),并且仅当两进气口有压力时才会有信号输出,较弱的信号从出口输出。
7.1.4 流量控制阀			
7.1.4.1	X10630 401V1 2031V1 201V4		流量控制阀,流量可调
7.1.4.2	X10640 401V1 2031V1 201V4 2162V1 2163V1 501V1 401V1		带单向阀的流量控制阀,流量可调

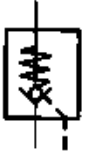
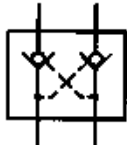
	注册号	图 形	描 述
7.1.4.3	X10650 101V7 F028V1 2172V1 RF038 2002V1 402V5 712V1		滚轮柱塞操纵的弹簧复位式流量控制阀
7.1.5 单向阀和梭阀			
7.1.5.1	X10700 2162V1 2163V1 401V1		单向阀,只能在一个方向自由流动
7.1.5.2	X10710 2162V1 2163V1 401V1 2002V1		带有复位弹簧的单向阀,只能在一个方向流动,常闭
7.1.5.3	X10720 2162V1 2163V1 401V1 2002V1 101V1 422V1		带有复位弹簧的先导式单向阀,先导压力允许在两个方向自由流动
7.1.5.4	X10730 101V1 2162V1 2163V1 422V1 401V1		双单向阀,先导式

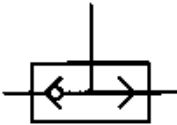
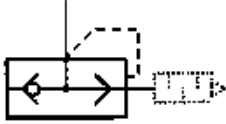
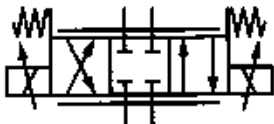
	注册号	图 形	描 述
7.1.5.5	X10740 101V16 2162V1 2163V1 501V2 401V1 401V2		梭阀(“或”逻辑),压力高的人口自动与出口接通
7.1.5.6	X10750 2031V1 101V16 2162V1 2163V1 501V2 401V1 401V2		快速排气阀
7.1.6 比例方向控制阀			
7.1.6.1	X10760 101V7 F026V1 F027V1 2172V1 RF038 101V2 212V1 201V2 2002V1 401V2		直动式比例方向控制阀

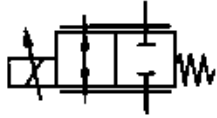
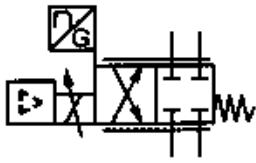
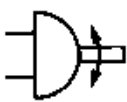

	注册号	图 形	描 述
7.1.7 比例压力控制阀			
7.1.7.1	X10830 101V7 F026V1 422V2 2002V1 101V2 212V1 201V2 401V2		直控式比例溢流阀,通过电磁铁控制弹簧工作长度来控制液压电磁换向座阀
7.1.7.2	X10840 101V7 F026V1 422V2 101V2 212V1 201V2 401V2 101V5 F052V1 401V2		直控式比例溢流阀,电磁力直接作用在阀芯上,集成电子器件
7.1.7.3	X10850 101V7 F026V1 422V2 2002V1 101V2 212V1 201V2 101V5 F052V1 753V1 F045V1 234V1 401V2		直控式比例溢流阀,带电磁铁位置闭环控制,集成电子器件

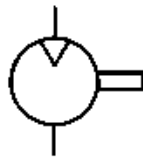
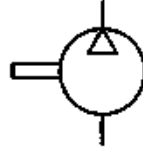
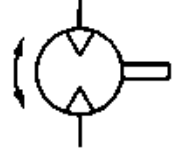
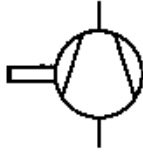
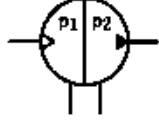

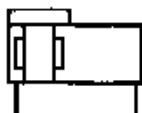
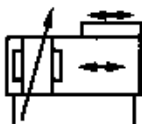
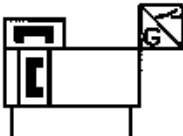
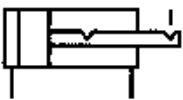
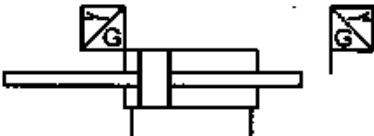

	注册号	图 形	描 述
7.1.8 比例流量控制阀			
7.1.8.1	X10890 101V7 F028V1 2172V1 RF038 2002V1 101V2 212V1 201V2 401V2		直控式比例流量控制阀
7.1.8.2	X10900 101V7 F027V1 2172V1 RF038 2002V1 101V2 212V1 201V2 101V5 F052V1 753V1 F045V1 234V1 401V2		带磁铁位置闭环控制和电子器件的直控式比例流量控制阀
7.2 空气压缩机和马达			
7.2.1	X11280 F003V1 256V1 F017V1 401V2		摆动气缸或摆动马达， 限制摆动角度，双向摆动

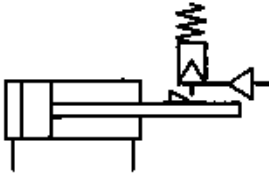
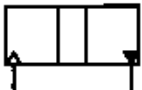
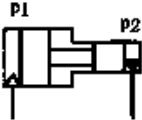

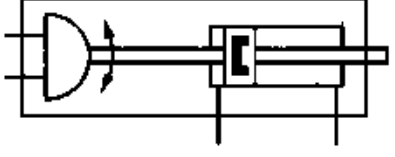

	注册号	图 形	描 述
7.2.2	X11290 F003V1 256V1 F017V1 401V2 2002V1		单作用的半摆动气缸或摆动马达
7.2.3	X11390 2065V1 244V1 F017V1 401V2		马达
7.2.4	X11400 2065V1 244V1 F017V1 401V2		空气压缩机
7.2.5	X11410 2065V1 244V1 F017V1 401V2 256V1		变方向定流量双向摆动马达
7.2.6	X11420 2065V1 F017V1 401V2 F023V1		真空泵
7.2.7	X11430 2065V1 243V2 244V2 401V2		连续增压器, 将气体压力 p_1 转换为较高的液体压力 p_2





	注册号	图 形	描 述
7.3 缸			
7.3.1	X11440 101V13 2002V3 101V14 F004V1 401V2		单作用单杆缸,靠弹簧力返回行程,弹簧腔室有连接口
7.3.2	X11450 101V13 101V14 F004V1 401V2		双作用单杆缸
7.3.3	X11460 101V13 101V14 F004V1 F004V2 101V19 201V7 401V2		双作用双杆缸,活塞杆直径不同,双侧缓冲,右侧带调节
7.3.4	X11470 101V13 F006V1 F004V1 F003V1 201V1 401V2		带行程限制器的双作用膜片缸
7.3.5	X11480 101V13 F004V1 F006V1 101V19 2002V3 2174V1 401V2		活塞杆终端带缓冲的膜片缸,不能连接的通气孔



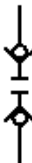

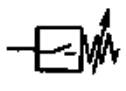

	注册号	图 形	描 述
7.3.6	X11520 101V13 101V14 101V19 101V20		双作用带状无杆缸, 活塞两端带终点位置缓冲
7.3.7	X11530 101V13 101V14 101V19 101V20 201V7 245V1 401V2		双作用缆索式无杆缸, 活塞两端带可调节终点位置缓冲
7.3.8	X11540 101V13 101V14 753V1 F045V1 F048V1 326V1 401V2		双作用磁性无杆缸, 仅右手终端位置切换
7.3.9	X11550 101V13 101V14 F004V1 655V1 F041V1 401V2		行程两端定位的双作用缸
7.3.10	X11560 101V13 101V14 F004V1 753V1 F045V1 F048V1 401V2		双杆双作用缸, 左终点带内部限位开关, 内部机械控制, 右终点有外部限位开关, 由活塞杆触发

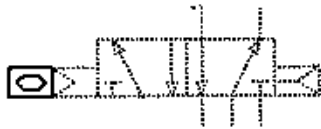

	注册号	图 形	描 述
7.3.11	X11570 101V13 101V14 F004V1 661V1 101V2 244V1 244V2 401V1 401V2		双作用缸, 加压锁定与解锁活塞杆机构
7.3.12	X11580 101V13 101V14 243V2 244V2 401V2		单作用压力介质转换器, 将气体压力转换为等值的液体压力, 反之亦然
7.3.13	X11590 F007V1 F008V1 243V2 244V2 401V2		单作用增压器, 将气体压力 p_1 转换为更高的液体压力 p_2
7.3.14	X11600 F069V1 RF047 401V2		波纹管缸
7.3.15	X11610 RF057 401V2		软管缸

	注册号	图 形	描 述
7.3.16	X11620 101V13 101V14 F004V1 326V1 F003V1 256V1 F017V1 401V1 401V2		半回转线性驱动, 永磁 活塞双作用缸
7.3.17	X11630 101V17 101V14 F009V1 326V1 F065V1 401V2		永磁活塞双作用夹具
7.3.18	X11640 101V17 101V14 F009V1 326V1 F065V1 401V2		永磁活塞双作用夹具
7.3.19	X11650 101V17 101V14 F009V1 326V1 F065V1 2002V4 401V2		永磁活塞单作用夹具



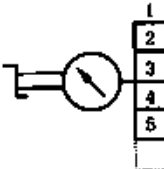

	注册号	图 形	描 述
7.3.20	X11660 101V17 101V14 F009V1 326V1 F065V1 2002V4 401V2		永磁活塞单作用夹具
7.4 附件			
7.4.1 连接和管接头			
7.4.1.1	X11670 501V1 452V1		软管总成
7.4.1.2	X11680 F036V1 RF004		三通旋转接头
7.4.1.3	X11690 2162V1 2172V1		不带单向阀的快换接头, 断开状态
7.4.1.4	X11700 2162V1 2163V1 2172V1		带单向阀的快换接头, 断开状态
7.4.1.5	X11710 2162V1 2163V1 2172V1		带双单向阀的快换接头, 断开状态

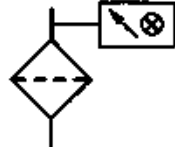
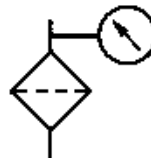
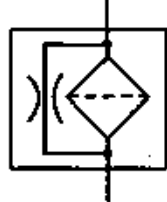

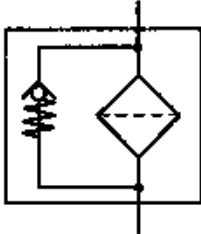
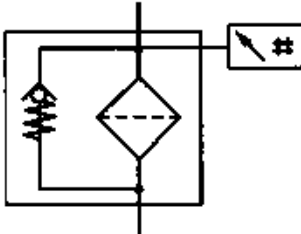
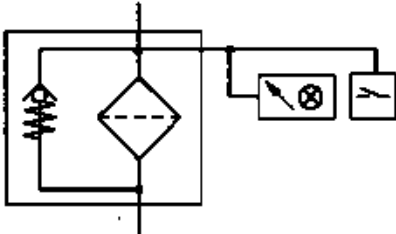
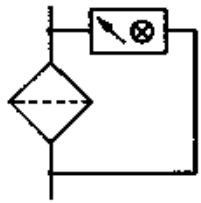
	注册号	图 形	描 述
7.4.1.6	X11720 2162V1 2172V1		不带单向阀的快换接头, 连接状态
7.4.1.7	X11730 2162V1 2163V1 2172V1		带单向阀的快换接头, 连接状态
7.4.1.8	X11740 2162V1 2163V1 2172V1		带双单向阀的快换接头, 连接状态
7.4.2 电气装置			
7.4.2.1	X11750 101V5 F050V1 2002V1 201V2 401V2		可调节的机械电子压力继电器
7.4.2.2	X11760 753V1 F045V1 F048V1 201V1 401V1 401V2		输出开关信号, 可电子调节的压力转换器
7.4.2.3	X11770 753V1 F045V1 234V1 401V2		模拟信号输出压力传感器

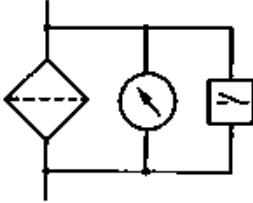

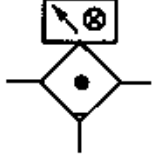

	注册号	图 形	描 述
7.4.2.4	X11780 101V2 F047V1		压电控制机构
7.4.3 测量仪和指示器			
7.4.3.1	X11790 101V6 148V1 F056V1		光学指示器
7.4.3.2	X11800 101V6 235V1 148V1		数字式指示器
7.4.3.3	X11810 101V6 148V1 F057V1		声音指示器
7.4.3.4	X11820 F002V1 148V1 401V2		压力测量仪表(压力表)
7.4.3.5	X11830 F002V1 148V1 401V2		压差计
7.4.3.6	X11840 F002V1 148V1 402V5 685V1 401V2		带选择功能的压力表



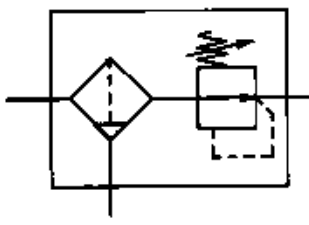
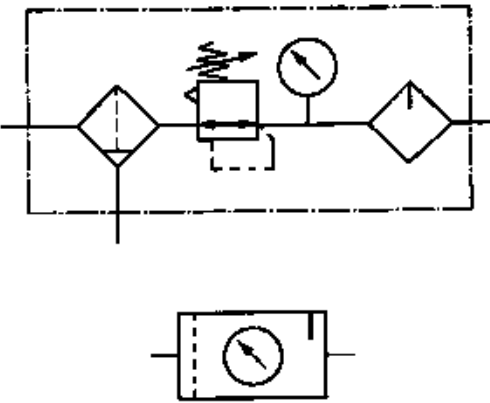

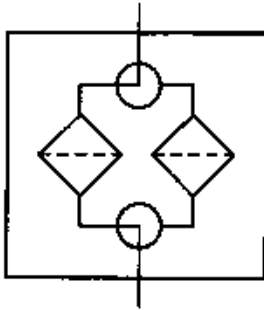
	注册号	图 形	描 述
7.4.3.7	X11950 101V6 F059V1 F050V1		开关式定时器
7.4.3.8	X11960 101V5 F060V1		计数器
7.4.4 过滤器和分离器			
7.4.4.1	X11980 101V15 F061V1 401V2		过滤器
7.4.4.2	X12010 101V15 F061V1 101V6 148V1 F056V1 401V2		带光学阻塞指示器的过滤器
7.4.4.3	X12020 101V15 F061V1 F002V1 148V1 422V1 401V2		带压力表的过滤器
7.4.4.4	X12030 101V15 F061V1 2031V1 501V1 401V1		旁路节流过滤器

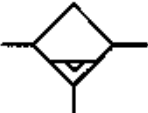
	注册号	图 形	描 述
7.4.4.5	X12040 101V15 F061V1 2002V1 2162V1 2163V1 501V1 401V1		带旁路单向阀的过滤器
7.4.4.6	X12050 101V15 F061V1 2002V1 2162V1 2163V1 501V1 101V6 148V1 235V1 401V1		带旁路单向阀和数字显示器的过滤器
7.4.4.7	X12060 101V15 F061V1 2002V1 2162V1 2163V1 501V1 101V6 148V1 235V1 401V1 101V5 F050V1 422V1		带旁路单向阀、光学阻塞指示器与电气触点的过滤器
7.4.4.8	X12070 101V15 F061V1 101V6 148V1 F056V1 401V2		带光学压差指示器的过滤器

	注册号	图 形	描 述
7.4.4.9	X12080 101V15 F061V1 F002V1 148V1 422V1 401V2 101V5 F050V1		带压差指示器与电气触点的过滤器
7.4.4.10	X12090 101V15 F066V1 401V2		离心式分离器
7.4.4.11	X12100 101V15 F062V1 F064V1 401V2		自动排水聚结式过滤器
7.4.4.12	X12110 101V15 F062V1 F064V1 101V6 148V1 F056V1 401V2		带手动排水和阻塞指示器的聚结式过滤器
7.4.4.13	X12120 101V15 F074V1 242V1 F028V1 401V1 401V2		双相分离器

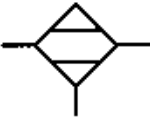

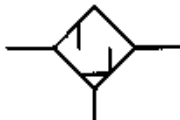
	注册号	图 形	描 述
7.4.4.14	X12130 101V15 F074V1 241V1 F063V1 401V1 401V2		真空分离器
7.4.4.15	X12140 101V15 F074V1 242V1 401V1 401V2		静电分离器
7.4.4.16	X12150 101V15 F064V1 422V1 101V7 F026V1 422V3 2002V1 201V2 401V1		不带压力表的 手动排水 过滤器,手动调节,无溢流
7.4.4.17	X12160 101V15 F064V1 422V1 101V7 F028V1 422V4 2174V1 2002V1 201V2 501V1 F002V1 148V1 401V1 422V1 401V		气源处理装置,包括手 动排水过滤器、手动调节 式溢流调压阀、压力表和 油雾器。 上图为详细示意图,下 图为简化图



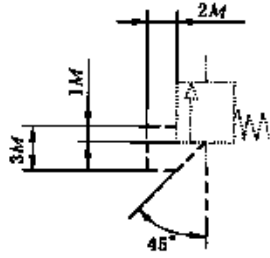
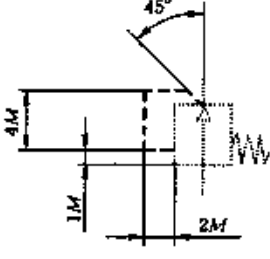
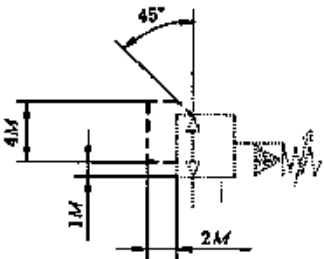

	注册号	图 形	描 述
7.4.4.18	X12170 101V15 422V1 F037V1 401V1		带手动切换功能的双过滤器
7.4.4.19	X12180 101V15 F064V1 401V2		手动排水流体分离器
7.4.4.20	X12190 101V15 F064V1 422V1 401V2		带手动排水分离器的过滤器
7.4.4.21	X12200 101V15 F065V1 401V2		自动排水流体分离器
7.4.4.22	X12210 101V15 2061V1 401V1 401V2		吸附式过滤器
7.4.4.23	X12220 101V15 422V1 401V2		油雾分离器

	注册号	图 形	描 述
7.4.4.24	X12230 101V15 F074V1 401V2		空气干燥器
7.4.4.25	X12240 101V15 401V1 401V2		油雾器
7.4.4.26	X12250 101V15 F064V1 401V1 401V2		手动排水式油雾器
7.4.4.27	X12310 101V15 F064V1 401V1 401V2		手动排水式重新分离器
7.4.5 蓄能器(压力容器,气瓶)			
7.4.5.1	X12370 F069V1 401V2		气罐
7.4.6 真空发生器			
7.4.6.1	X12380 101V1 2031V1 401V1		真空发生器

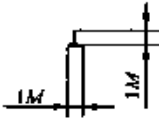

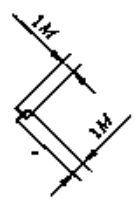
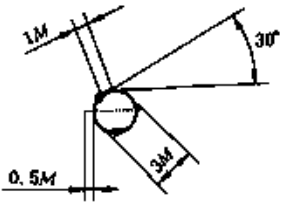
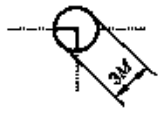

	注册号	图 形	描 述
7.4.6.2	X12390 2031V1 101V1 2162V1 2163V1 2002V1 401V2		带集成单向阀的单级真空发生器
7.4.6.3	X12400 101V1 F022V1 2162V1 2163V1 501V1 401V1		带集成单向阀的三级真空发生器
7.4.6.4	X12410 101V7 F027V1 101V2 212V1 202V1 2031V1 2162V1 2163V1 501V1 401V1 422V1		带放气阀的单级真空发生器
7.4.7 吸盘			
7.4.7.1	X12420 F073V1 2002V1 401V2		吸盘
7.4.7.2	X12430 F073V1 2162V1 2163V1 2002V1 401V2		带弹簧压紧式推杆和单向阀的吸盘

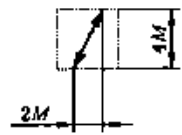
8 图形符号的基本要素			
8.1 线			
	注册号	图 形	描 述
8.1.1	401V1		供油管路,回油管路,元件外壳和外壳符号(见GB/T 4457.4、GB/T 17450、GB/T 18686)
8.1.2	422V1		内部和外部先导(控制)管路,泄油管路,冲洗管路,放气管路(见GB/T 4457.4、GB/T 17450、GB/T 18686)
8.1.3	F001V1		组合元件框线(见GB/T 4457.4、GB/T 17450、GB/T 18686)
8.2 连接和管接头			
8.2.1	501V1		两个流体管路的连接
8.2.2	501V2		两个流体管路的连接(在一个符号内表示)
8.2.3	401V2		接口
8.2.4	F035V1		控制管路或泄油管路接口

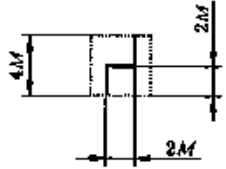
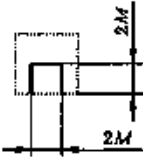
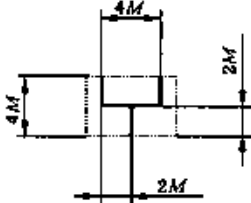
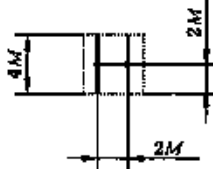
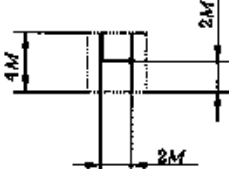
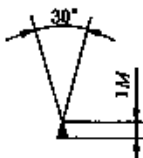

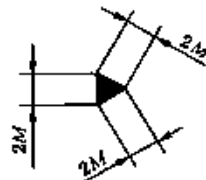

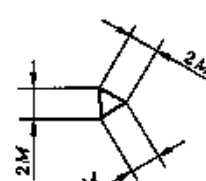
	注册号	图 形	描 述
8.2.5	422V2		位于溢流阀内的控制管路
8.2.6	422V3		位于减压阀内的控制管路
8.2.7	422V4		位于三通减压阀内的控制管路
8.2.8	452V1		软管管路
8.2.9	2172V1		封闭管路或接口

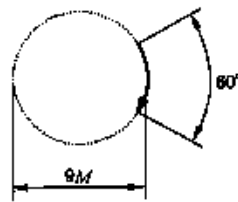
	注册号	图 形	描 述
8.2.10	F038V1		液压管路内堵头
8.2.11	F036V1		旋转管接头
8.2.12	F037V1		三向旋塞阀
8.3 流路和方向指示			
8.3.1	F026V1		流体流过阀的路径和方向
8.3.2	F027V1		流体流过阀的路径和方向
8.3.3	F028V1		流体流过阀的路径和方向
8.3.4	F029V1		流体流过阀的路径和方向

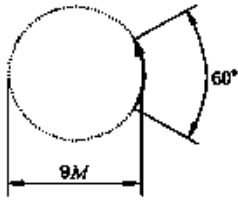
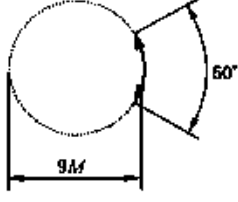
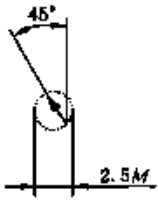
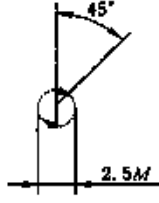
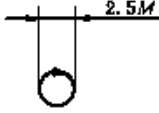
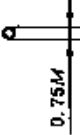
	注册号	图 形	描 述
8.3.5	F030V1		阀内部的流动路径
8.3.6	F031V1		阀内部的流动路径
8.3.7	F032V1		阀内部的流动路径
8.3.8	F033V1		阀内部的流动路径
8.3.9	F034V1		阀内部的流动路径
8.3.10	242V1		流体流动方向

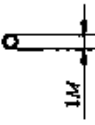
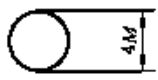

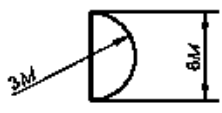
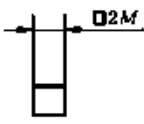
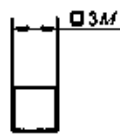
	注册号	图 形	描 述
8.3.11	243V2		液压力作用方向
8.3.12	243V1		液压力作用方向
8.3.13	244V2		气压力作用方向
8.3.14	244V1		气压力作用方向
8.3.15	241V1		线性运动的方向指示
8.3.16	245V1		线性运动的双方向指示
8.3.17	255V1		顺时针方向旋转指示 箭头。

	注册号	图 形	描 述
8.3.18	255V2		逆时针方向旋转指示箭头
8.3.19	256V1		双方向旋转指示箭头
8.3.20	148V1		元件指示箭头, 指示压力
8.3.21	F024V1		扭矩指示
8.3.22	F025V1		速度指示
8.4 机械基本要素			
8.4.1	2163V2		单向阀运动部分, 小规格

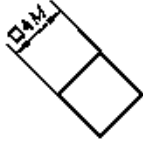
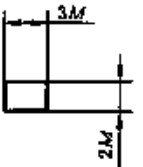
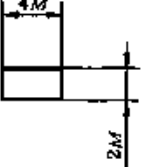
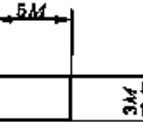
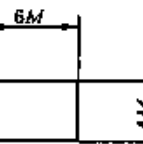
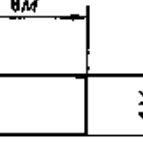
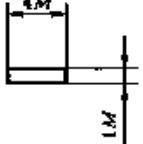
	注册号	图 形	描 述
8.4.2	2163V1		单向阀运动部分, 大规格
8.4.3	F002V1		测量仪表框线(控制元件, 步进电机)
8.4.4	2065V1		能量转换元件框线(泵, 压缩机, 马达)
8.4.5	F003V1		摆动泵或马达框线(旋转驱动)
8.4.6	101V21		控制方法框线(简略表示), 蓄能器重锤
8.4.7	101V5		开关, 变换器和其他器件框线
8.4.8	101V7		最多四个主油口阀的功能单元
8.4.9	101V12		马达驱动部分框线(内燃机)

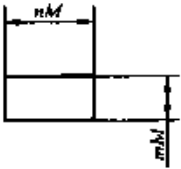
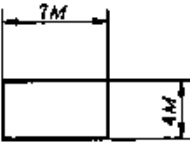
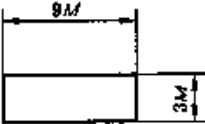
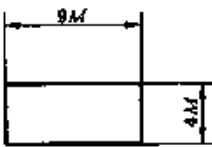
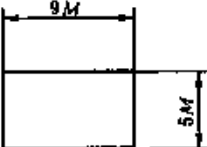
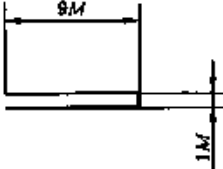
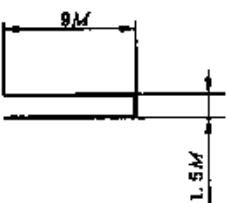
	注册号	图 形	描 述
8.4.10	101V15		流体处理装置框线(过滤器,分离器,油雾器和热交换器)
8.4.11	101V2		控制方法框线(标准图)
8.4.12	101V3		控制方法框线(拉长图)
8.4.13	101V6		显示装置框线
8.4.14	101V8		五个主油口阀的功能单元
8.4.15	101V16		双压阀的功能单元 (“与”逻辑)
8.4.16	101V20		无杆缸支架

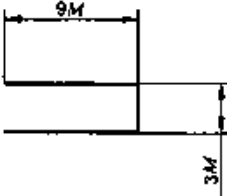
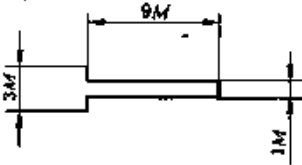
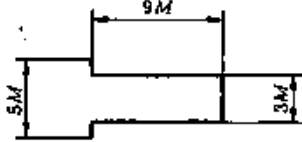
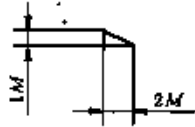
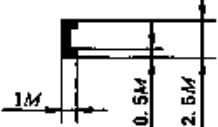
	注册号	图 形	描 述
8.4.17	101V1		功能单元
8.4.18	101V17		夹具框线
8.4.19	101V18		柱塞缸活塞杆
8.4.20	101V13		缸
8.4.21	101V22		伸缩缸框线
8.4.22	F004V1		活塞杆
8.4.23	F004V2		大直径活塞杆

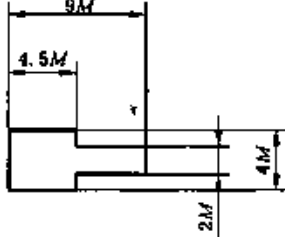
	注册号	图 形	描 述
8.4.24	F004V3		伸缩缸活塞杆
8.4.25	F005V1		双作用伸缩缸活塞杆
8.4.26	F005V2		双作用伸缩缸活塞杆
8.4.27	661V1		要求独立控制元件解锁的锁定装置
8.4.28	326V1		永久磁铁
8.4.29	F006V1		膜片活塞
8.4.30	F007V1		增压器壳体

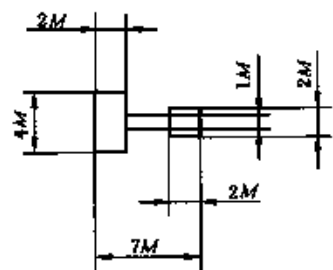
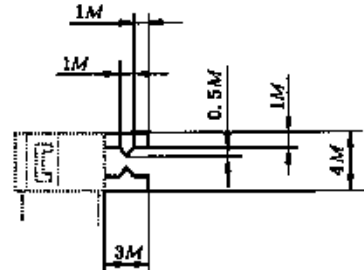
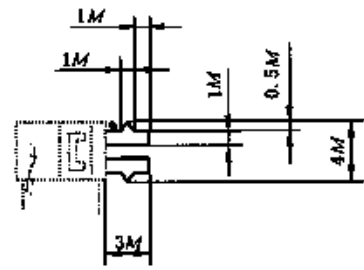
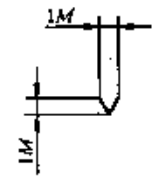
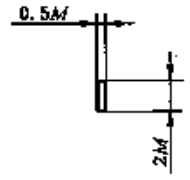
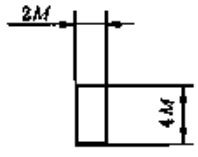
	注册号	图 形	描 述
8. 4. 31	F008V1		增压器活塞
8. 4. 32	F009V1		外部夹具元件
8. 4. 33	F009V2		内部夹具元件
8. 4. 34	2174V1		无连接排气管
8. 4. 35	101V19		缸内缓冲
8. 4. 36	101V14		缸的活塞

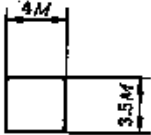
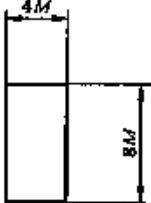
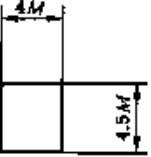
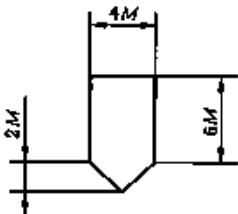
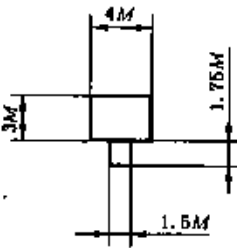
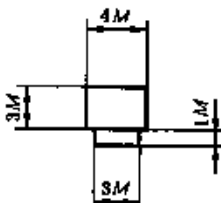
	注册号	图 形	描 述
8.4.37	101V9		盖板式插装阀圆柱阀芯
8.4.38	101V10		盖板式插装阀的嵌入式安装,滑阀结构
8.4.39	101V11		盖板式插装阀的圆柱阀芯,滑阀结构
8.4.40	F010V1		盖板式插装阀安装区域
8.4.41	F011V1		盖板式插装阀的圆柱阀芯,座阀结构
8.4.42	F012V1		盖板式插装阀的圆柱阀芯,座阀结构

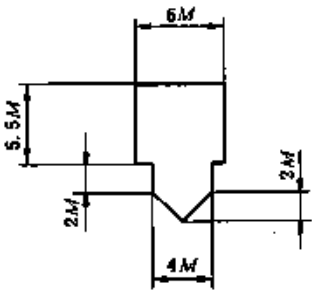
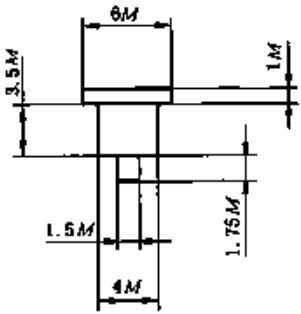
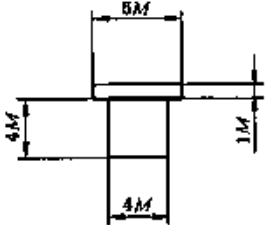
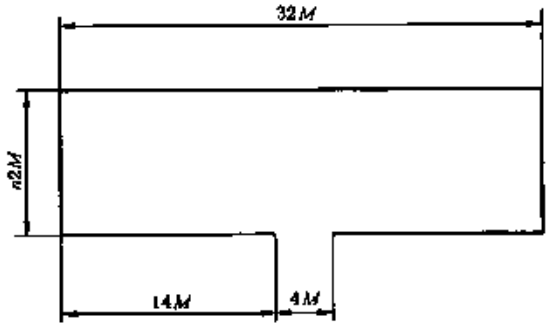
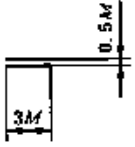

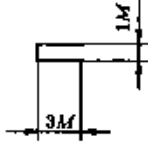
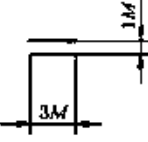
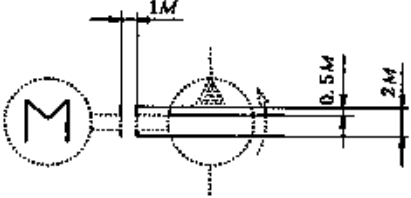
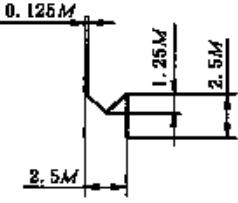
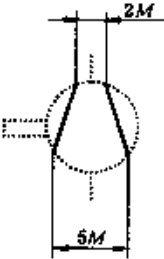
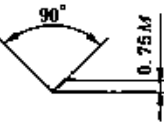
	注册号	图 形	描 述
8.4.43	F013V1		盖板式插装阀的嵌入式安装, 内置主动座阀结构
8.4.44	F014V1		盖板式插装阀的圆柱阀芯, 内置主动座阀结构
8.4.45	F015V1		盖板式插装阀的活塞, 内置主动座阀结构
8.4.46	F016V1		无口控制盖, 盖的最小高度尺寸为 4M, 为实现功能扩展, 盖子高度应该调整为 2M 的倍数
8.4.47	402V1		机械连接, 轴, 杆, 机械反馈

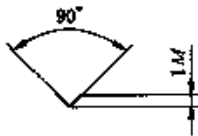
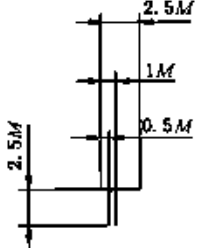
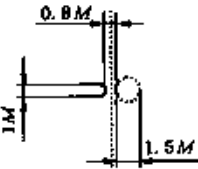
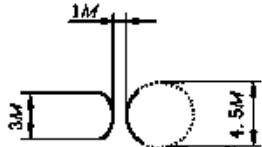
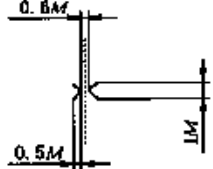
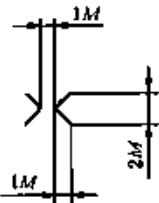
	注册号	图 形	描 述
8.4.48	F017V1		机械连接(轴,杆)
8.4.49	402V5		机械连接,轴,杆,机械反馈
8.4.50	F018V1		轴连接
8.4.51	F019V2		M 表示马达,与符号为 2065V1 的元件连接
8.4.52	F023V1		真空泵元件
8.4.53	2162V2		单向阀阀座,小规格

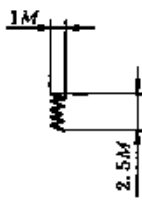
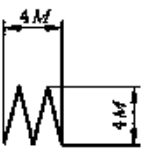
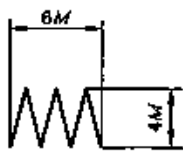
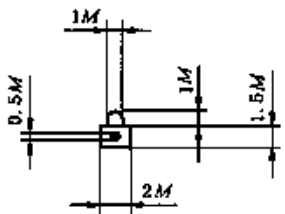
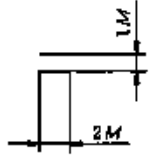
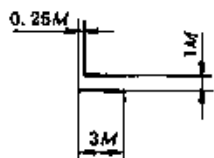
	注册号	图 形	描 述
8.4.54	2162V1		单向阀阀座,大规格
8.4.55	F020V1		机械行程限制
8.4.56	2031V21		节流器(小规格)
8.4.57	2031V1		流量控制阀,节流通道 节流,取决于黏度
8.4.58	F021V1		节流孔(小规格)
8.4.59	F022V1		节流孔,锐边节流孔节 流,很大程度取决于黏度

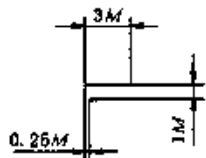
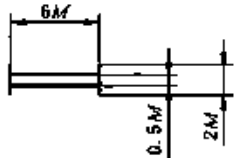
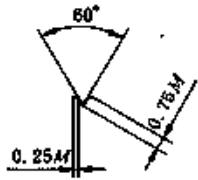
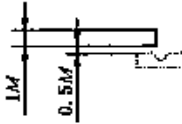
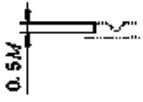
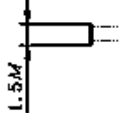
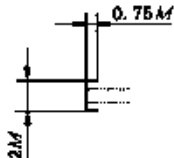
	注册号	图 形	描 述
8.4.60	2002V2		嵌入弹簧
8.4.61	2002V4		夹具弹簧
8.4.62	2002V3		油缸弹簧
8.5 控制机构要素			
8.5.1	F039V1		锁定元件(锁)
8.5.2	402V2		机械连接, 轴, 杆
8.5.3	402V3		机械连接, 轴, 杆

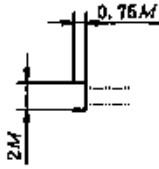
	注册号	图 形	描 述
8.5.4	402V4		机械连接,轴,杆
8.5.5	F040V1		双压阀的机械连接
8.5.6	655V1		定位机构
8.5.7	F041V1		定位锁
8.5.8	658V1		非定位位置指示
8.5.9	681V2		手动控制元件
8.5.10	682V1		推力控制机构元件

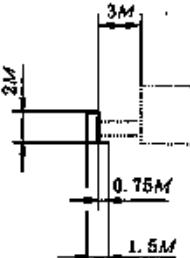
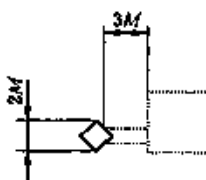
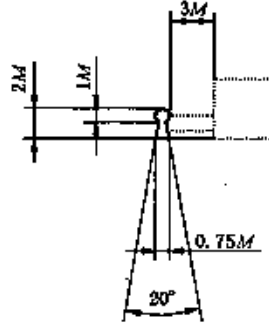

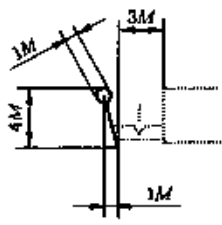
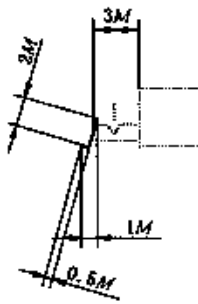
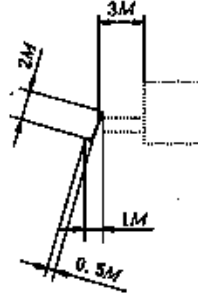
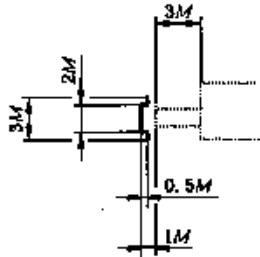
	注册号	图 形	描 述
8.5.11	683V1		拉力控制机构元件
8.5.12	684V1		推拉控制机构元件
8.5.13	685V1		回转控制机构元件
8.5.14	686V1		控制元件:可动把手
8.5.15	687V1		控制元件:匙

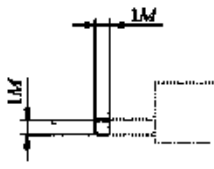
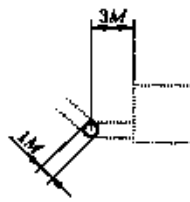
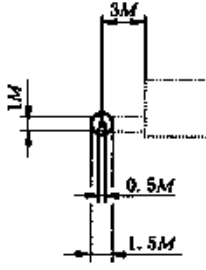
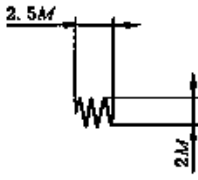
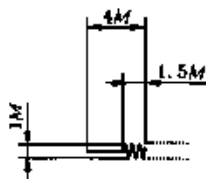
	注册号	图 形	描 述
8.5.16	688V1		控制元件:手柄
8.5.17	689V1		控制元件:踏板
8.5.18	690V1		控制元件:双向踏板
8.5.19	692V1		控制机构限制装置

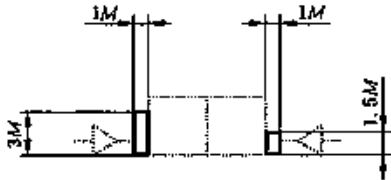
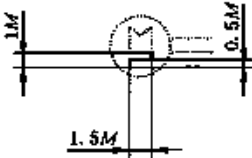
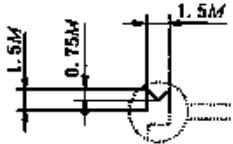
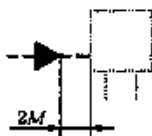
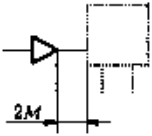
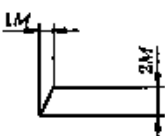
	注册号	图 形	描 述
8.5.20	711V1		控制元件:活塞
8.5.21	2005V1		旋转节点连接
8.5.22	712V1		控制元件:滚轮
8.5.23	2002V1		控制元件:弹簧
8.5.24	F042V1		控制元件:带控制机构 弹簧

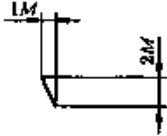
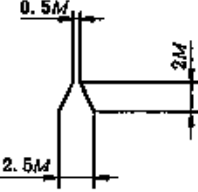
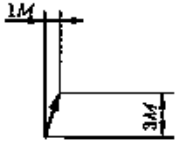
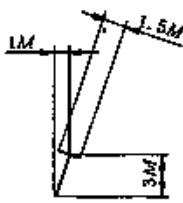
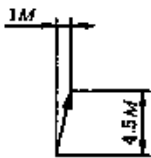
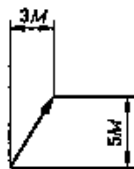
	注册号	图 形	描 述
8.5.25	2177V1		不同尺寸的反向控制面积 的直动机构
8.5.26	2111V1		步进可调符号
8.5.27	F019V2		M 表示与符号为 F002V1 的元件连接的 马达
8.5.28	F043V1		液压增压直动机构(用 于方向控制阀)
8.5.29	F044V1		气压增压直动机构(用 于方向控制阀)
8.5.30	212V1		控制元件;绕组,作用方 向指向阀芯(电磁铁,力矩 马达,力马达)

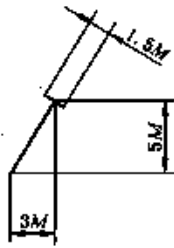
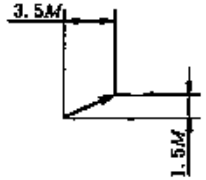
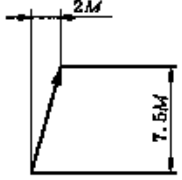
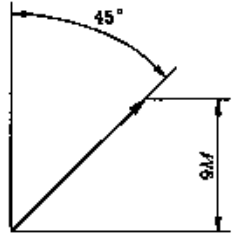
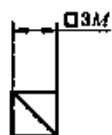

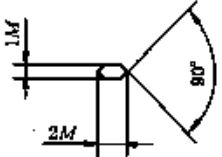
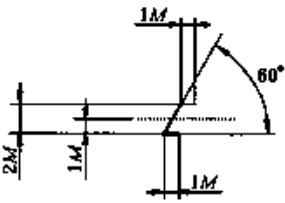
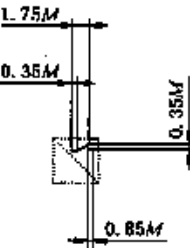
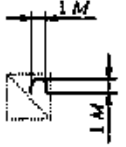

	注册号	图 形	描 述
8.5.31	212V2		控制元件:绕组,作用方向背离阀芯(电磁铁,力矩马达,力马达)
8.5.32	212V4		控制元件:双绕组,反方向作用
8.6 调节要素			
8.6.1	201V1		可调整,如行程限制
8.6.2	203V1		预设置,如行程限制
8.6.3	201V2		弹簧或比例电磁铁的可调整
8.6.4	201V3		节流孔的可调整

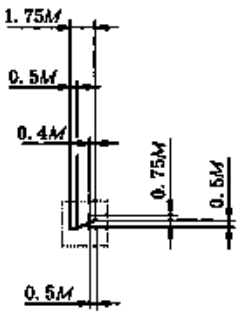
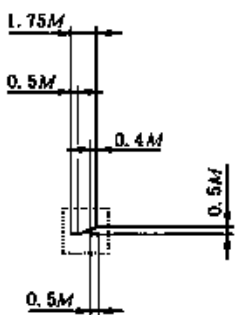
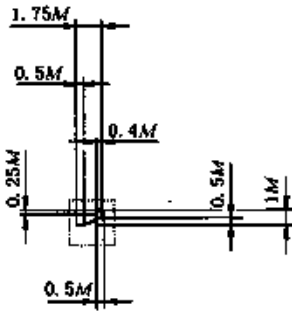
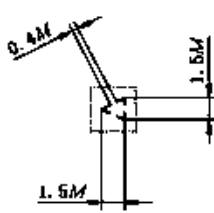
	注册号	图 形	描 述
8.6.5	203V2		预设置, 节流孔
8.6.6	201V4		节流器的可调整
8.6.7	201V7		末端缓冲的可调整
8.6.8	201V5		泵或马达的可调整
8.7 附件			
8.7.1	753V1		信号转换, 常规, 测量传感器
8.7.2	753V2		信号转换, 常规, 测量传感器

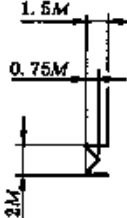
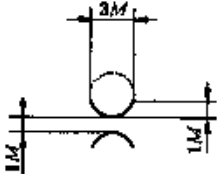
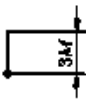
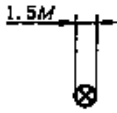
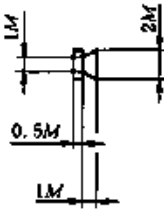
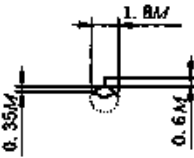
	注册号	图 形	描 述
8.7.3	F045V1		*—输入信号, **—输出信号
8.7.4	F046V1	<p>F—流量; G—位置或长度测量; L—液位; P—压力或真空; S—速度或频率; T—温度; W—质量或力</p>	输入信号
8.7.5	F047V1		压电控制机构元件
8.7.6	435V1		导线符号
8.7.7	F048V1		输出信号, 电控开关
8.7.8	234V1		输出信号, 电气模拟信号

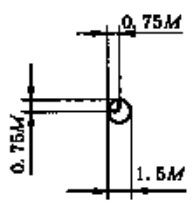

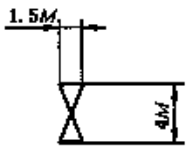
	注册号	图 形	描 述
8.7.9	235V1		输出信号, 电气数字信号
8.7.10	F049V1		电气接触, 常开触点
8.7.11	F050V1		电气接触, 常闭触点
8.7.12	F051V1		电气接触, 开关触点
8.7.13	F052V1		集成电子器件

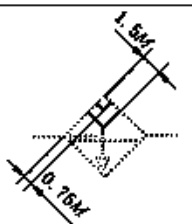
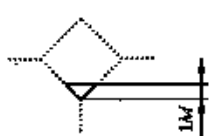

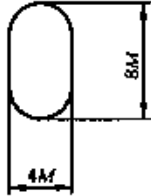
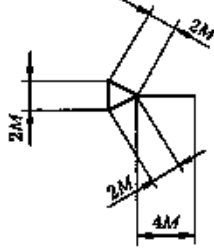
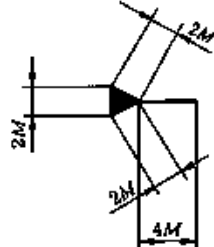
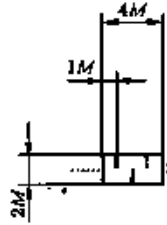
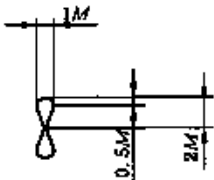
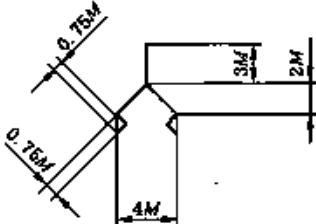

	注册号	图 形	描 述
8.7.14	1103V1		液位指示
8.7.15	F053V1		加法器符号
8.7.16	F054V1		流量指示
8.7.17	F055V1		温度指示
8.7.18	F056V1		光学指示器元件
8.7.19	F057V1		声音指示器元件
8.7.20	F058V1		浮子开关元件

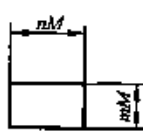
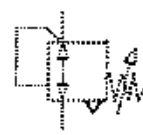
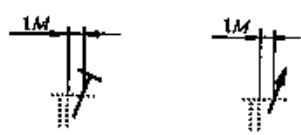

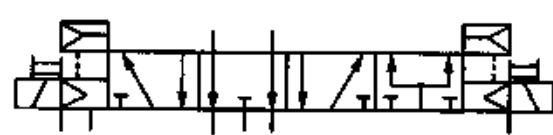
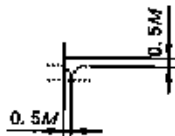
	注册号	图 形	描 述
8.7.21	F059V1		时控单元元件
8.7.22	F060V1		计数器元件
8.7.23	2101V1		截止阀
8.7.24	F061V1		过滤器元件
8.7.25	F062V1		过滤器聚结功能
8.7.26	F063V1		过滤器真空功能
8.7.27	F064V1		流体分离器元件, 手动排水

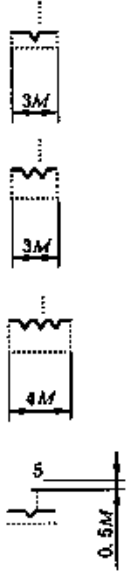
	注册号	图 形	描 述
8.7.28	F074V1		分离器元件
8.7.29	F065V1		自动流体分离器元件
8.7.30	F066V1		离心式过滤器元件
8.7.31	F067V1		热交换元件
8.7.32	F068V1		有盖油箱
8.7.33	2061V1		回到油箱



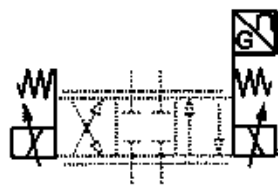

	注册号	图 形	描 述
8.7.34	F069V1		元件： 一压力容器， 一压缩空气储气罐，蓄能器， 一气瓶，波纹管执行器， 软管气缸
8.7.35	F070V1		气压源
8.7.36	F071V1		液压源
8.7.37	2033V1		消音器
8.7.38	F072V1		风扇
8.7.39	F073V1		吸盘

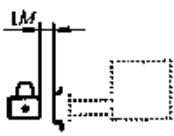
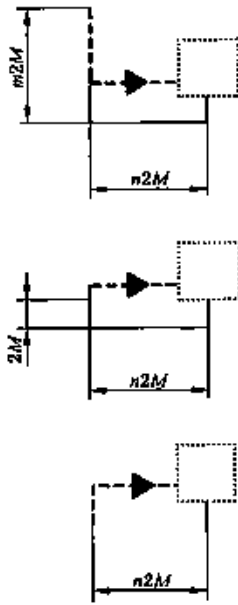
9 应用规则			
9.1 常规符号			
	注册号	图 形	描 述
9.1.1	RF001		功能单元大小可能会随需要而改变
9.1.2	RF002		当功能需要时,无连接排气口应当标明
9.1.3	RF003		元件应中心位置放置且与相应符号有 1M 间隔
9.2 阀			
9.2.1	RF004		<p>控制机构中心线位于长方形或正方形底边之上 1M。</p> <p>平行作用的附加控制机构中心线为 2M 间距,在功能部件底边之下不能有突出</p>
9.2.2	RF005		<p>根据控制机构的工作状况,操作端的控制机构可使阀体元件从空闲的位置进入与其邻近的一个位置。</p> <p>同时操纵四位阀两端的控制机构可以控制阀体从空闲位置移越两个位置</p>
9.2.3	RF006		定位锁机构应放置在中间,或者在距凹口右或左 0.5M 的位置,且在轴上方 0.5M 处

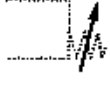
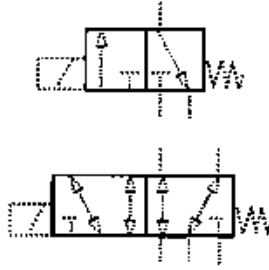
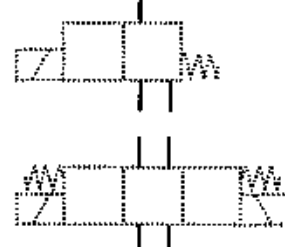
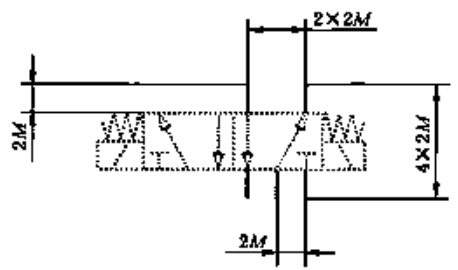
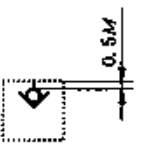

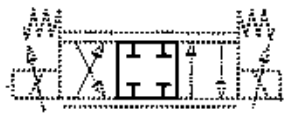

	注册号	图 形	描 述
9.2.4	RF007		<p>定位槽应对称置于轴上。对于三个以上的定位,数量应标注在定位槽上方0.5M处</p>
9.2.5	RF008		<p>如有必要,无定位的切换位置应当标明</p>
9.2.6	RF009		<p>控制机构应在图中相应的矩形/长方形中直接标明</p>
9.2.7	RF010		<p>控制机构应画在矩形或长方形图的右侧,除非两侧均有</p>
9.2.8	RF011		<p>如果符号的尺寸不适合控制机构,需要画出延长线,在功能元件的两侧均可</p>

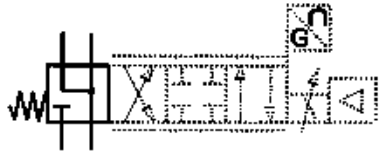
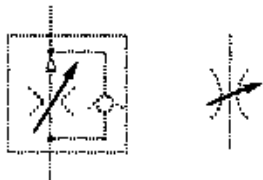
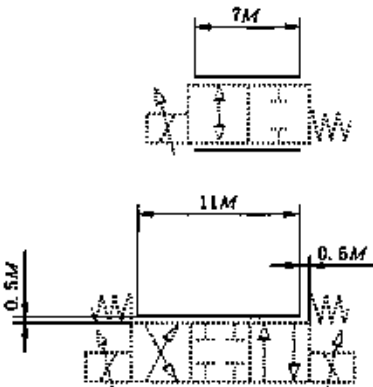

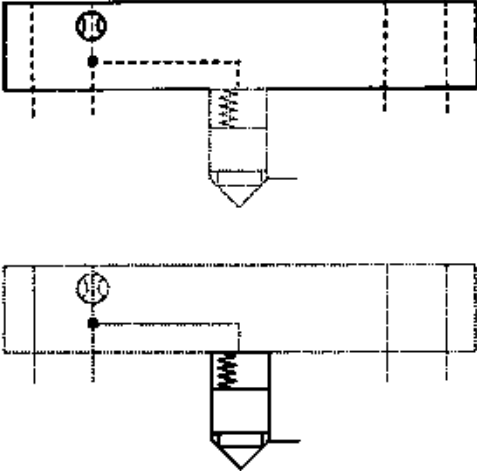
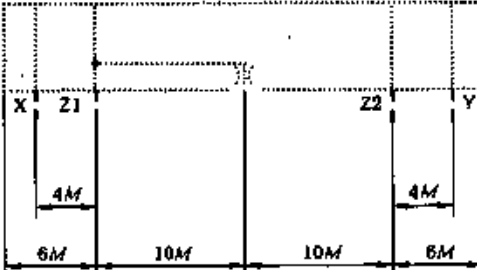
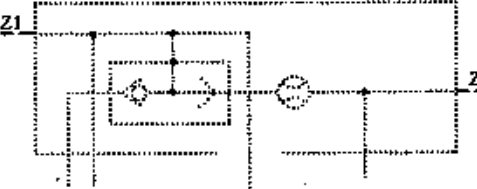
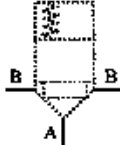

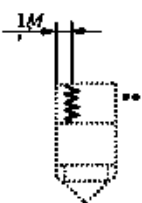
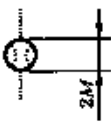
	注册号	图 形	描 述
9.2.9	RF012		<p>控制机构和信号转换器并行运行时从底部到顶部应遵循以下顺序：</p> <ul style="list-style-type: none"> — 液动或气动； — 电磁铁； — 弹簧； — 手动控制元件； — 转换器。 <p>如果同样的控制机构装载于功能元件的两侧，其顺序必须对称放置。不允许符号重叠</p>
9.2.10	RF013		<p>控制机构串联工作时应依照同样的控制次序按顺序表示</p>
9.2.11	RF014		<p>锁定符号应在距离可锁装置 1M 距离外标出，该锁定符号表示可锁定的调整</p>
9.2.12	RF015		<p>符号设计时应使接口末端在 2M 的倍数的网格上</p>



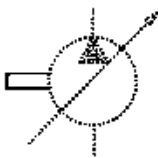
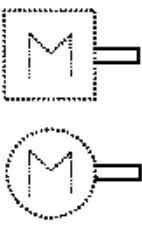

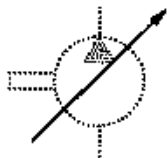
	注册号	图 形	描 述
9.2.13	RF016		单绕组比例电磁铁
9.2.14	RF017		弹簧的可调整
9.2.15	RF018		阀符号由各种功能单元组成,每一种功能单元代表一种阀芯位置和不同作用方式
9.2.16	RF019		应标识出功能单元上的工作油口,并表示功能单元未受激励的状态(非工作状态)
9.2.17	RF020		符号连接用 2M 的倍数表示。相邻连接线的距离应为 2M,以保证接口标识码的标注空间
9.2.18	RF021		功能:防漏隔离,液压电磁换向座阀

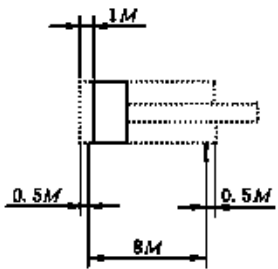

	注册号	图 形	描 述
9.2.19	RF022		功能,内部流路限流(零遮盖至负遮盖)
9.2.20	RF023		压力控制阀符号的基本位置由流动方向决定。供油口通常画在底部
9.2.21	RF024		代表比例、快速响应伺服阀的中位机能,零遮盖或正遮盖
9.2.22	RF025		代表比例、快速响应伺服阀的中位机能,零遮盖或负遮盖(至3%)
9.2.23	RF026		控制系统外部应显示设置自动防故障装置
9.2.24	RF027		可调整要素符号应位于节流器或节流孔的中心位置
9.2.25	RF028		对于有两个或更多工作位置,或有多个中间位置且彼此节流特性各不相同的阀,应沿符号画两条平行线

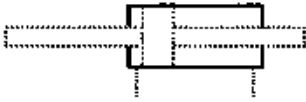

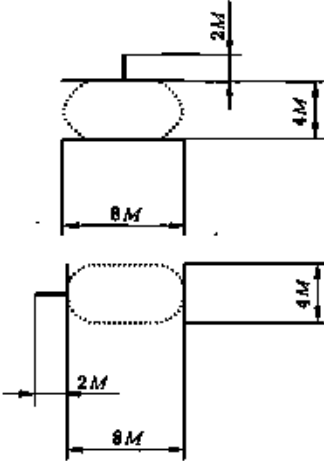
	注册号	图 形	描 述
9.3 二通盖板式插装阀			
9.3.1	RF029		<p>二通插装阀符号包括两个部分：控制盖板和插装阀芯。插装阀芯与控制盖板涵盖了更基础的元件或符号</p>
9.3.2	RF030		<p>控制盖板的连接应位于框图中网格节点上,其位置固定</p>
9.3.3	RF031		<p>应画出外部连接</p>
9.3.4	RF032		<p>工作油口位于底部和符号侧边。A口位于底部，B口在右边或在左边或两边都有</p>

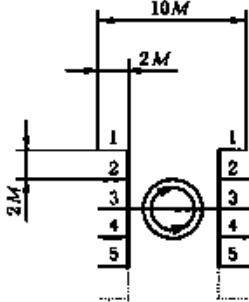
	注册号	图 形	描 述
9.3.5	RF033		阀的开启压力应在符号 旁边标明(**)
9.3.6	RF034		如果节流孔是可代替 的,其符号应圈上一个 圆圈
9.3.7	RF035		盖板式插装阀,座阀结 构,阀芯面积比 $\frac{AA}{AX} \leq 0.7$
9.3.8	RF036		盖板式插装阀,座阀 结构,圆柱阀芯面积比 $1 > \frac{AA}{AX} > 0.7$
9.3.9	RF037		对于有节流功能的二通 插装阀,阀芯部位应涂满
9.4 泵和马达			
9.4.1	RF038		泵的驱动轴位于左边 (首选位置)或右边,且可 延伸 2M 的倍数
9.4.2	RF039		马达的轴位于右边(首 选位置),也可置于左边

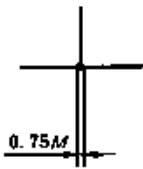
	注册号	图 形	描 述
9.4.3	RF040		<p>表示可调整的箭头应置于能量转换装置符号的中心。如果需要,可画得更长些</p>
9.4.4	RF041		<p>顺时针方向箭头表示泵的轴顺时针方向旋转,并画在泵的轴的对侧。旋转方向由在部件面对轴末端的视角给出。 注意:当这个部件符号镜像时,指示旋转方向的箭头应当反向</p>
9.4.5	RF042		<p>逆时针方向箭头表示泵的轴逆时针方向旋转,并画在泵的轴的对侧。旋转方向由在部件面对轴末端的视角给出。 注意:当这个部件符号镜像时,指示旋转方向的箭头应当反向</p>
9.4.6	RF043		<p>泵或马达的泄油管路表示在其右下底部斜度小于45度,位于位移轴和驱动轴之间</p>
9.5 缸			
9.5.1	RF044		<p>活塞应距离缸端量 $1M$ 以上。连接油口的管路距离缸的符号末端应当在 $0.5M$ 以上</p>

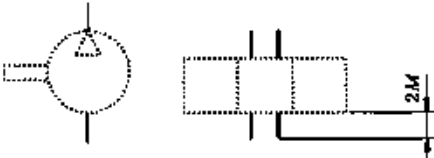
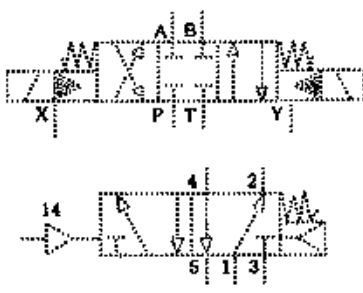
	注册号	图 形	描 述
9.5.2	RF045		缸的框图应与活塞杆符号元件相匹配
9.5.3	RF046		行程限制应在端盖末端标出
9.5.4	RF047		机械行程应以对称方式标出
9.5.5	RF048		可调整机能应由标识在调节元件中的箭头指示。两个元件的可调整机能应表示在可调元件之间的中间位置
9.6 附件			
9.6.1 管接头			
9.6.1.1	RF049		多路旋转管接头图中两边接口都有 2M 间隔。图中数字可自定义并扩展。接口牌号表示在接口符号上方

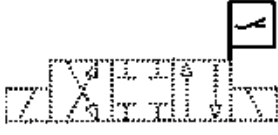
	注册号	图 形	描 述
9.6.1.2	RF050		<p>两条管路的连接标出连接点</p>
9.6.1.3	RF051		<p>两条管路交叉没有节点表明它们之间没有连接</p>
9.6.1.4	RF052		<p>应标出所有接口的符号</p>
9.6.1.5	RF053		<p>各种口的符号示例： A—油口； B—油口； P—泵； T—油箱； X—先导控制； Y—先导式泄油； 3,5—回油或排气口； 2,4—工作口； 1—供油或供气口； 14—控制口。</p> <p>在每个口的上方或左边，对于每个口的牌号必须留出充足的空间进行标识。对每个口的字母或数字示例，液压符合 ISO 9461、气动符合 ISO 11727</p>

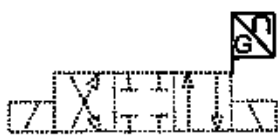
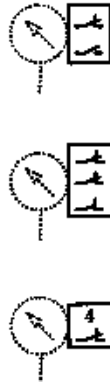
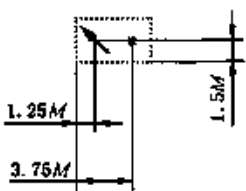
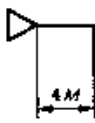
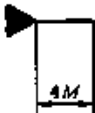
	注册号	图 形	描 述
9.6.2 电气装置			
9.6.2.1	RF054		位置开关,机电式,如阀芯位置
9.6.2.2	RF055		带切换输出信号的电控接近开关,如监视方向控制阀中的阀芯位置
9.6.2.3	RF056		带模拟信号输出的位置信号转换器
9.6.2.4	RF057		<p>同一个图中至少可以有一个触点。每一个触点可以有不同功能(常闭触点,常开触点,开关触点)。</p> <p>如果存在三个以上触点,触点的数量可标示在图中位于触点上方 0.5M 位置</p>
9.6.3 测量设备和指示器			
9.6.3.1	RF058		所示单元中箭头和星号的位置,* 详细描述的位置
9.6.4 能量源			
9.6.4.1	RF059		气压源
9.6.4.2	RF060		液压源

附录 A
(资料性附录)
CAD 符号介绍

A.1 CAD 对象命名		
	图 形	描 述
A.1.1		<p>部分 1(Segment 1)确定原对象。</p> <p>部分 2(Segment 2)包含三个字符(三字段),这三个字符来源于原对象英文单词的首字母。</p> <p>例如:LINE=LIN; TEXT=TEX。</p> <p>部分 3(Segment 3)描述原对象的进一步特征,由单独元素组成。它能由几个通过下划线连接的三字段组成</p>
A.1.2		<p>接入点(IP)通常置于流体供油管路上</p>
A.2 符号中元素的 CAD 描述		
A.2.1		<p>层名:ISO_LIN_UNI;</p> <p>颜色:黄;</p> <p>色号:50;</p> <p>线型:实线;</p> <p>描述:符号代表的通用管路</p>
A.2.2		<p>层名:ISO_LIN_FLU;</p> <p>颜色:绿;</p> <p>色号:70;</p> <p>线型:实线;</p> <p>描述:表示流体流动的管路</p>

	图 形	描 述
A. 2.3		层名: ISO_LIN_HAT; 颜色: 灰; 色号: 9; 线型: 满线; 描述: 交叉影线
A. 2.4		层名: ISO_TEX_IDE; 颜色: 绿; 色号: 70; 线型: 实线; 描述: 接口标示符
A. 2.5		层名: ISO_TEX_POS; 颜色: 深蓝; 色号: 4; 线型: 实线; 描述: 位置编号
A. 2.6		层名: ISO_TEX_DES; 颜色: 黄; 色号: 50; 线型: 实线; 描述: 描述符
A. 3 非智能符号中元素的 CAD 描述		
A. 3.1		层名: ISO_LIN_PRE; 颜色: 橙(赤黄)色; 色号: 30; 线型: 实线; 描述: 压力管路
A. 3.2		层名: ISO_LIN_RES; 颜色: 蓝色; 色号: 140; 线型: 实线; 描述: 回油管路

	图 形	描 述
A. 3.3		层名: ISO_LIN_CON; 颜色: 橙(赤黄)色; 色号: 30; 线型: 虚线(均匀长间隔线); 描述: 控制管路
A. 3.4		层名: ISO_LIN_DRA; 颜色: 蓝色; 色号: 140; 线型: 虚线(均匀短间隔线); 描述: 泄油管路
A. 3.5		层名: ISO_LIN_WOR; 颜色: 绿; 色号: 70; 线型: 实线; 描述: 工作管路
A. 3.6		层名: ISO_LIN_LIM; 颜色: 青绿色; 色号: 120; 线型: 点画线; 描述: 限制线
A. 3.7		层名: ISO_TEX_DES_025; 颜色: 绿; 色号: 70; 线型: 实线; 描述: 描述文本 2.5 mm
A. 3.8		层名: ISO_TEX_DES_035; 颜色: 橙色; 色号: 30; 线型: 实线; 描述: 描述文本 3.5 mm
A. 3.9		层名: ISO_TEX_DES_050; 颜色: 黄; 色号: 50; 线型: 实线; 描述: 描述文本 5 mm



	图 形	描 述
A.4 功能符号的 CAD 描述示例		
A.4.1		层名: ISO_LIN_UNI
A.4.2		层名: ISO_LIN_FLU
A.4.3		层名: ISO_LIN_HAT
A.4.4		层名: ISO_TEX_POS
A.4.5		层名: ISO_TEX_IDE
A.4.6		层名: ISO_TEX_DES

	图 形	描 述
A. 5 CAD 图形符号的特征		
A. 5. 1	 <p>The diagram shows a hydraulic cylinder symbol on a grid. The cylinder is represented by a rectangle with a piston rod extending to the right. An arrow points from the left towards the cylinder, indicating flow direction. A star symbol labeled 'IP' is positioned at the bottom left of the cylinder, representing the inlet point at the end cap connection.</p>	接入点(IP)在液压缸端盖的联接处
A. 5. 2	 <p>The diagram shows a pump symbol on a grid. The pump is represented by a circle with a triangle inside, pointing upwards. A horizontal line enters the circle from the left, representing the suction port. A star symbol labeled 'IP' is positioned at the bottom of the circle, representing the inlet point at the suction port.</p>	接入点(IP)在泵的吸油口
A. 5. 3	 <p>The diagram shows a check valve symbol on a grid. The valve is represented by a vertical line with a spring and a check symbol (a triangle pointing downwards) in the middle. A star symbol labeled 'IP' is positioned at the bottom of the valve, representing the inlet point at the inlet.</p>	接入点(IP)在单向阀的入口
A. 5. 4	 <p>The diagram shows a flow control valve symbol on a grid. The valve is represented by a vertical line with a diamond shape in the middle, indicating flow control. A star symbol labeled 'IP' is positioned at the bottom of the valve, representing the inlet point at the inlet.</p>	接入点(IP)在流量控制阀的入口

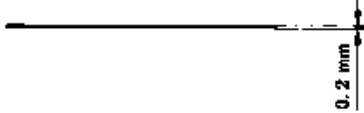
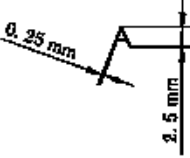
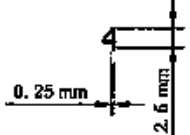
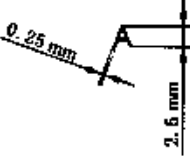
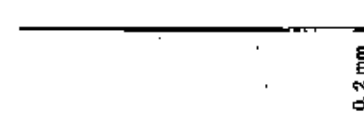
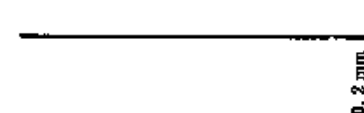
	图 形	描 述
A. 5. 5		<p>接入点(IP)在方向控制阀的人口</p>
A. 5. 6		<p>接入点(IP)在压力控制阀的人口</p>
A. 5. 7		<p>插装阀控制盖板的接入点(IP)在控制盖板底边的中心</p>

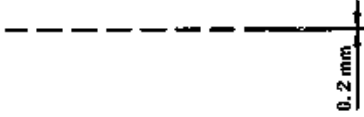
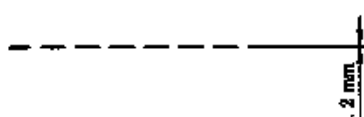
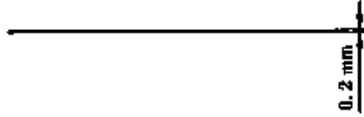
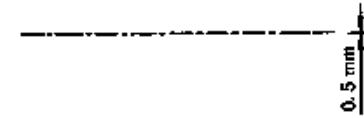
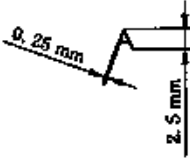
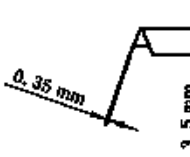
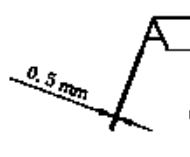
参 考 文 献

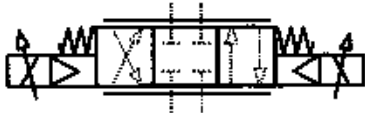
- [1] ISO 1219-2 流体传动系统和元件 图形符号和回路图 第2部分:回路图.
 - [2] ISO 3511-2 过程测量的控制功能和仪表设备 符号表示法 第2部分:基本要求的补充.
 - [3] ISO 3511-3 过程测量的控制功能和仪表设备 符号表示法 第3部分:仪表连接图上的详细符号.
 - [4] ISO 9461 液压传动 阀的油口、底板、控制装置和电磁铁的标注.
 - [5] ISO 11727 气压传动 控制阀和其他元件的气口、控制机构的标注.
-

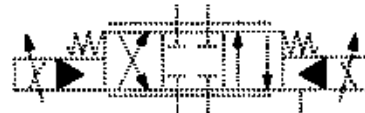
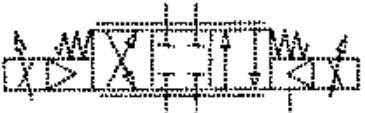
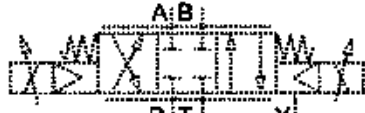
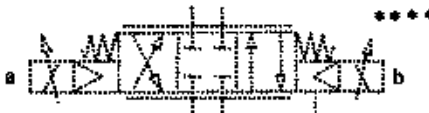
中华人民共和国
国家标准
流体传动系统及元件图形符号和回路图
第1部分：用于常规用途和数据处理的
图形符号

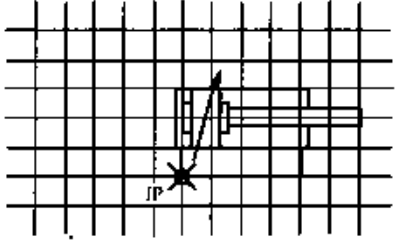
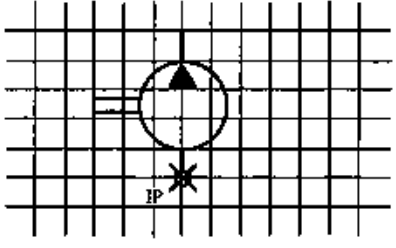
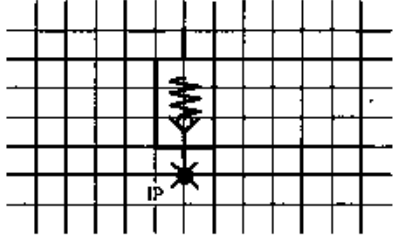
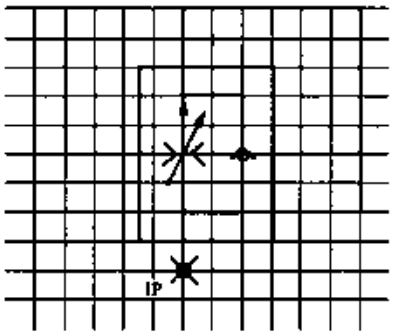
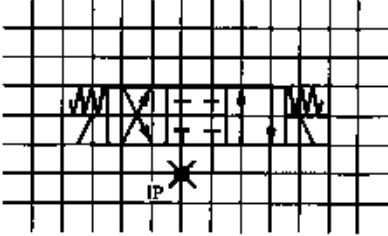
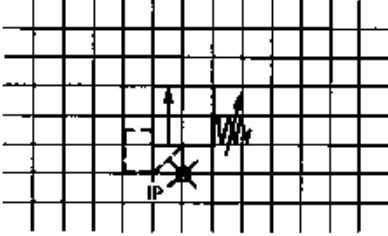
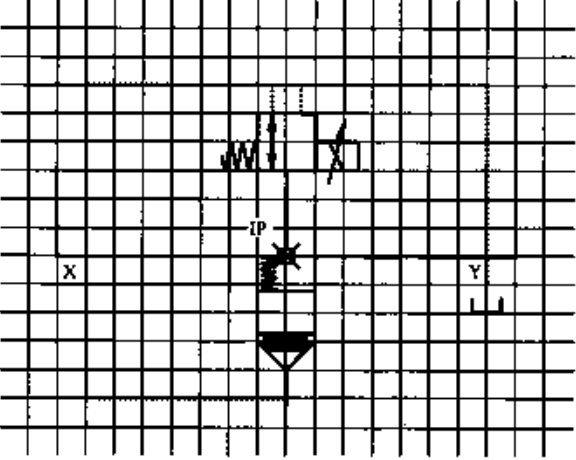
GB/T 786.1—2009/ISO 1219-1:2006

*

中国标准出版社出版发行
北京复兴门外三里河北街16号
邮政编码：100045

网址 www.spc.net.cn

电话：68523946 68517548

中国标准出版社秦皇岛印刷厂印刷
各地新华书店经销

*

开本 880×1230 1/16 印张 8.25 字数 255 千字
2009年7月第一版 2009年7月第一次印刷

*

书号：155066·1-37234 定价 100.00 元

如有印装差错 由本社发行中心调换
版权专有 侵权必究
举报电话：(010)68533533



GB/T 786.1-2009